



**LPC-2AxM Series P-cap Panel PC  
LGA1700 13<sup>th</sup>/12<sup>th</sup> Gen., Core-i7/5/3  
User Manual**

**Published in Taiwan**

**Release Date : Oct., 2023**

**Revision : V0.1**

# Warning!

This equipment generates, uses and can radiate radio frequency energy and if not installed and used in accordance with the instruction manual, it may cause interference to radio communications. It has been tested and found to comply with the limits for a Class A computing device pursuant to FCC Rules, which are designed to provide reasonable protection against such interference when operated in a commercial environment. Operation of this equipment in a residential area is likely to cause interference in which case the user at his own expense will be required to take whatever measures may be required to correct the interference.

Electric Shock Hazard – Do not operate the machine with its back cover removed. There are dangerous high voltages inside.

## Disclaimer

This information in this document is subject to change without notice. In no event shall ELGENS Co., Ltd. be liable for damages of any kind, whether incidental or consequential, arising from either the use or misuse of information in this document or in any related materials.

## Packing List

Accessories (as ticked) included in this package are:
<input type="checkbox"/> Panel Mounting Kits
<input type="checkbox"/> 3 Pin Male Terminal Block
<input type="checkbox"/> Optional Adapter
<input type="checkbox"/> Other. _____ (please specify)

## Safety Precautions

Follow the messages below to avoid your systems from damage:

- ◆ Avoid your system from static electricity on all occasions.
- ◆ Prevent electric shock. Don't touch any components of this card when the card is power-on. Always disconnect power when the system is not in use.
- ◆ Disconnect power when you change any hardware devices. For instance, when you connect a jumper or install any cards, a surge of power may damage the electronic components or the whole system.

# Table of Contents

<b>Chapter 1</b>	<b>Getting Started.....</b>	<b>5</b>
1.1	Brief Description of LPC P-cap 2AxM Series .....	5
1.2	System Specifications .....	5
1.3	Naming Rule.....	7
1.4	Dimension.....	9
1.5	Top / Bottom IO View .....	12
1.6	Motherboard Layout.....	13
<b>Chapter 2</b>	<b>Installation .....</b>	<b>15</b>
2.1	Remove Heatsink .....	15
2.2	Installation of DRAM.....	16
2.3	Installation of HDD (for 2AxM Series).....	17
2.4	Installation of Low-Profile PCI-Express Cards (for 2AxM Series) .....	19
<b>Chapter 3</b>	<b>UEFI SETUP UTILITY .....</b>	<b>21</b>
3.1	Entering and Control.....	21
3.1.1	UEFI Menu .....	21
3.1.2	Control in UEFI .....	22
3.2	Main.....	23
3.3	Advanced .....	24
3.3.1	CPU Configuration .....	25
3.3.2	Chipset Configuration .....	27
3.3.3	Storage Configuration .....	29
3.3.4	Super IO Configuration .....	30
3.3.5	ACPI Configuration.....	31
3.3.6	USB Configuration.....	32
3.3.7	Trusted Computing .....	33
3.4	Hardware Health Event Monitoring Screen.....	34
3.5	Security.....	35
3.6	Boot .....	36
3.7	Exit .....	37
<b>Chapter 4</b>	<b>Installation Drivers .....</b>	<b>38</b>
4.1	Chipset Driver Installation .....	38
4.1.1	Select “Chipset-10.1.19165.8332-Public-MUP” folder and execute “SetupChipset.exe” ..	38
4.1.2	Please follow the red blank. ....	38
4.2	Graphics Driver Setup .....	41
4.2.1	Select “ Intel_VGA(v31.0.101.4146)” folder and execute “GFX_win_101.4146.exe” .....	41
4.2.2	Please follow the red blank. ....	41

4.3	Audio Driver Setup.....	44
4.3.1	Select "Audio(9239_FF00)" folder and execute "Setup.exe" .....	44
4.3.2	Please follow the red blank. ....	44
4.4	LAN Driver Setup.....	46
4.4.1	Go to " Intel LAN 27.7" folder and choose " Autorun.exe" .....	46
4.4.2	Please follow the red blank. ....	46
4.5	ME Driver Setup.....	50
4.5.1	Go to "ME(v16.0.15.1620_CORP_SW_DCH)" and choose "SetupME.exe" .....	50
4.5.2	Please follow the red blank. ....	50

## History ..... 53

# Chapter 1 Getting Started

## 1.1 Brief Description of LPC P-cap 2AxM Series

The LPC P-cap 2AxM series is a power-optimized and delivers robust performance-per-watt for embedded HMI, powered by an up to TDP 35W Intel 13<sup>th</sup>/12<sup>th</sup> Gen., Core-i7/5/3/Celeron processors with H610 PCH. It comes with a Bezel-Free design, M.2 Key-M slot and an Internal 2.5-inch storage bay, up to 64GB DDR4-3200 memory, 1 PCIe16 slot, 1 HDMI2.0b, 2 DP1.4a++ ports, audio jack, 2 Ethernet, 2 USB 3.2 (Gen2) and 2 USB2.0 ports. The unit supports Windows 10 operation system.

The Elgens' fanless touch panel computer is ideal for use as Web Browser, Terminal, HMI at all levels of automation control or a high-performance system that working on rash environment.

## 1.2 System Specifications

Model Number	LPC-P150S-2AxMT	LPC-P170S-2AxMT	LPC-P215W-2AxMT
Max Resolution	1024*768	1280*1024	1920*1080
Color	16.7M	16.7M	16.7M
Luminance	400 nits	350 nits	350 nits
View Angle (H/V)	160/140	160/140	178/178
Contrast Ratio	800	800	1000
<b>Computing</b>			
Processor	Socket LGA 1700 for 13th/12th Intel® Core i7/i5/i3/Celeron (Supports up to 35W)		
System Memory	2 x SO-DIMM, up to 64 GB DDR4-3200 Intel® Core i3/Pentium®/Celeron® CPUs support up to 64GB (32GB per DIMM)		
Storage	1 x M.2 Key-M slot 2 x External 2.5" Storage Bay 1 x Internal 2.5" Storage Bay (Optional by 2AxM Series)		
External I/O Port	2 x USB 3.2 Gen2 2 x USB 2.0 2 x 2.5GbE LAN 2 x Display Port 1 x HDMI 2 x RS-232/422/485 1 x Audio out 1 x Mic in 1 x Power press button 1 x 3-Pin Power Input		

Expansion Slots	1 x M.2 (Key E, 2230) with PCIe x1, USB 2.0 and CNVi for Wireless 1 x M.2 (Key B, 3042/3052) with PCIe x1/USB3.2 Gen1/USB 2.0 and SIM for 4G/5G 1 x PCIe x16 (Gen4) (Optional by 2AxM Series)		
OS support	Windows IoT Enterprise LTSC, Linux by request		
<b>Touch Screen</b>			
Type	USB P-cap Touch		
Light Transmission	Up to 90%		
<b>Power Supply</b>			
Power Input	<ul style="list-style-type: none"> <li>■ DC12V ~ 28V Power Input</li> <li>■ 3-Pins Terminal Block or DC Jack</li> </ul>		
<b>Mechanical</b>			
Dimension (W x H x D)	358.5 x 281.5 x 84mm	392.3 x 324.7 x 84mm	537.8 x 329.3 x 84mm
Construction	Aluminum Heatsink and Metal Case		
IP Rating	Front Panel compliant IP65		
Mounting	Panel Mount & VESA		
<b>Environmental</b>			
Operating Temperature	-20~60 °C -30~70 °C (Optional by Heat-Pipe Model)		
Storage Temperature	-30~70 °C		
Storage Humidity	10~90% @40 °C non-condensing		

# 1.3 Naming Rule

## Model Naming Rule

**LPC-P 156 WH-2 X-EU**

Panel PC series

- For Internal: Power Adapter Type**
- Motherboard Model:** Please reference MB model list
- Chassis Version:** Please reference chassis description

Key Feature:	
H = High Brightness 1000 nits LED backing	AR = Anti-Reflection
OB = Optical Bonding	V = Vandal Proof Glass
G = Glass without touch	T = Backside Heatsink for Operating Temperature 60°C
AG = Anti-Glare	
B = Power Board for input on board fuse / Input reverse protection / Over current protection / Output short circuit protection	

- TFT-LCD Proportion:** S=Square ,W=Wide
- TFT-LCD Dimension:** 101=10.1" ,104=10.4" ,121=12.1" .....
- Touch Type:** P=P-cap+Bezel-Less R=Resistive+Bezel-Less

WWW.ELGENS.COM.TW  
**Customize Flexible Solutions**



Order Information	
LPC-Pxxxx- <b>2A3M</b>	Bezel-Free P-cap Panel PC with <b>12<sup>th</sup> Gen., Core i3</b> , Low-Profile Add-on Card, DC 24V Power Input, including a 3-Pin Power Adapter
LPC-Pxxxx- <b>2A5M</b>	Bezel-Free P-cap Panel PC with <b>12<sup>th</sup> Gen., Core i5</b> , Low-Profile Add-on Card, DC 24V Power Input, including a 3-Pin Power Adapter
LPC-Pxxxx- <b>2A7M</b>	Bezel-Free P-cap Panel PC with <b>12<sup>th</sup> Gen., Core i7</b> , Low-Profile Add-on Card, DC 24V Power Input, including a 3-Pin Power Adapter
LPC-Pxxxx- <b>2A3MT</b>	Bezel-Free P-cap Panel PC with <b>12<sup>th</sup> Gen., Core i3</b> , Dual Storage Tray, DC 24V Power Input, including a 3-Pin Power Adapter
LPC-Pxxxx- <b>2A5MT</b>	Bezel-Free P-cap Panel PC with <b>12<sup>th</sup> Gen., Core i5</b> , Dual Storage Tray, DC 24V Power Input, including a 3-Pin Power Adapter
LPC-Pxxxx- <b>2A7MT</b>	Bezel-Free P-cap Panel PC with <b>12<sup>th</sup> Gen., Core i7</b> , Dual Storage Tray, DC 24V Power Input, including a 3-Pin Power Adapter

Order Code	
<b>LPC-PxxxS/W</b>	-H / -OB / -AG / -AR / -B / -V
P = P-Cap touch	
B = Glass without touch	
xxx = size, For example, 10.1" = 101	
S = Dimension Ratio Square = 4:3 or 5:4	
W= Dimension Ration Wide = 16:9 or 16:10	
H = High Brightness 1000 nits LED backlight (Optional, up to 1600 nits backlight, by LCD limited)	
OB = Optical Bonding (Optional)	
AG = Anti-Glare (Optional)	
AR = Anti-Reflection (Optional)	
V = Vandal Proof Glass (Optional)	



# 1.4 Dimension

## LPC-P150S-2AxMT Drawing

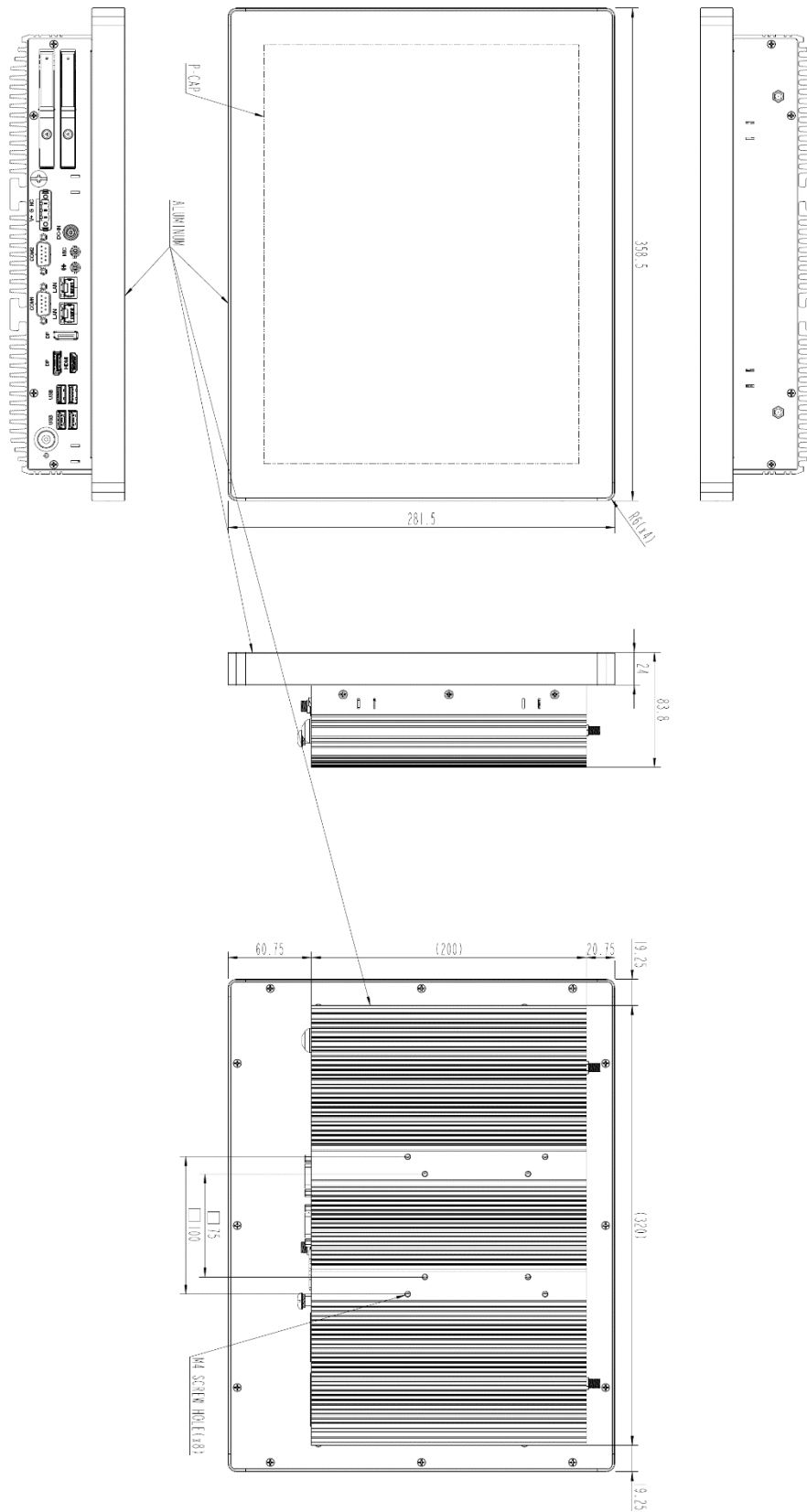

# LPC-P170S-2AxMT Drawing

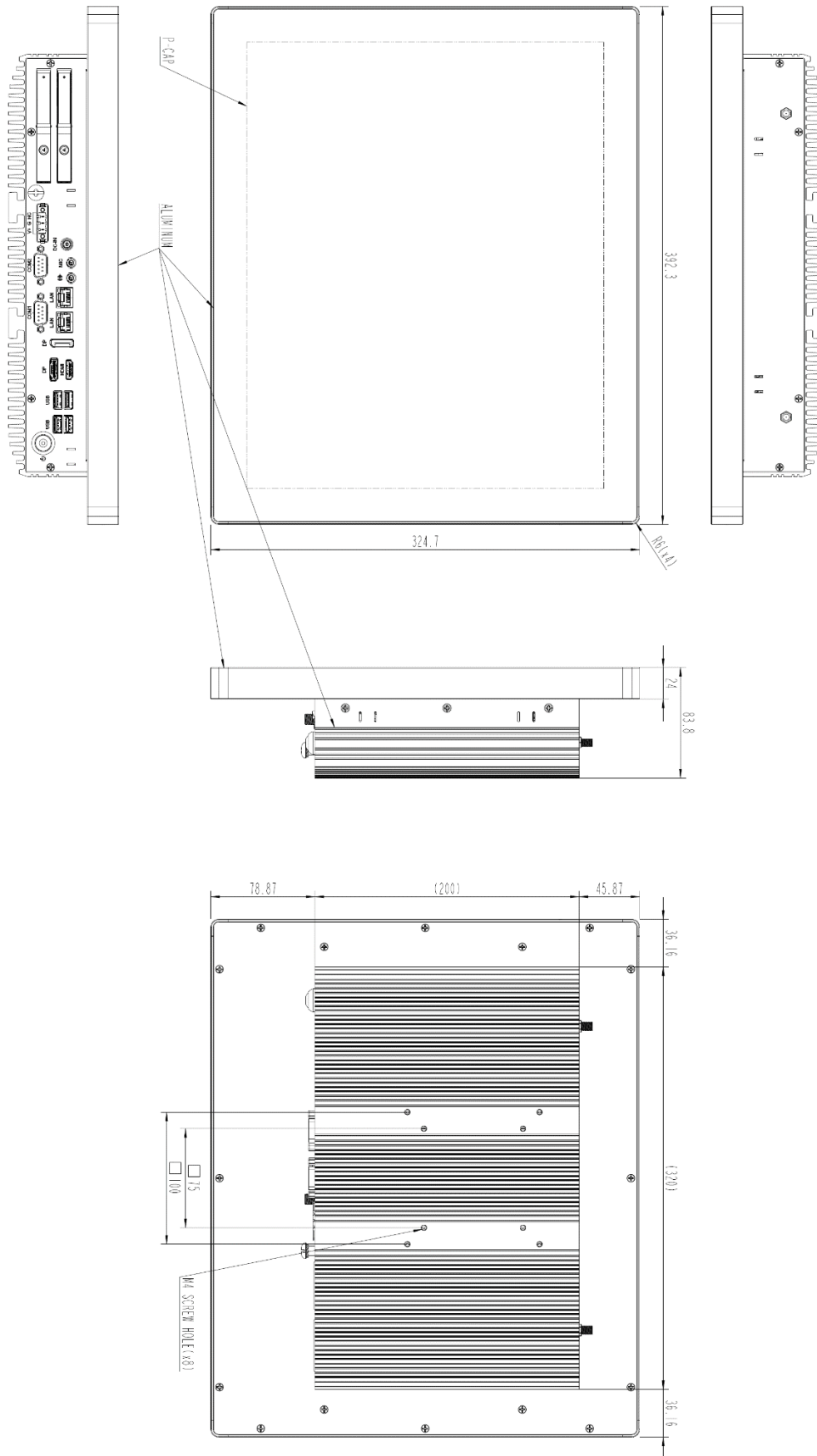

# LPC-P215W-2AxMT Drawing

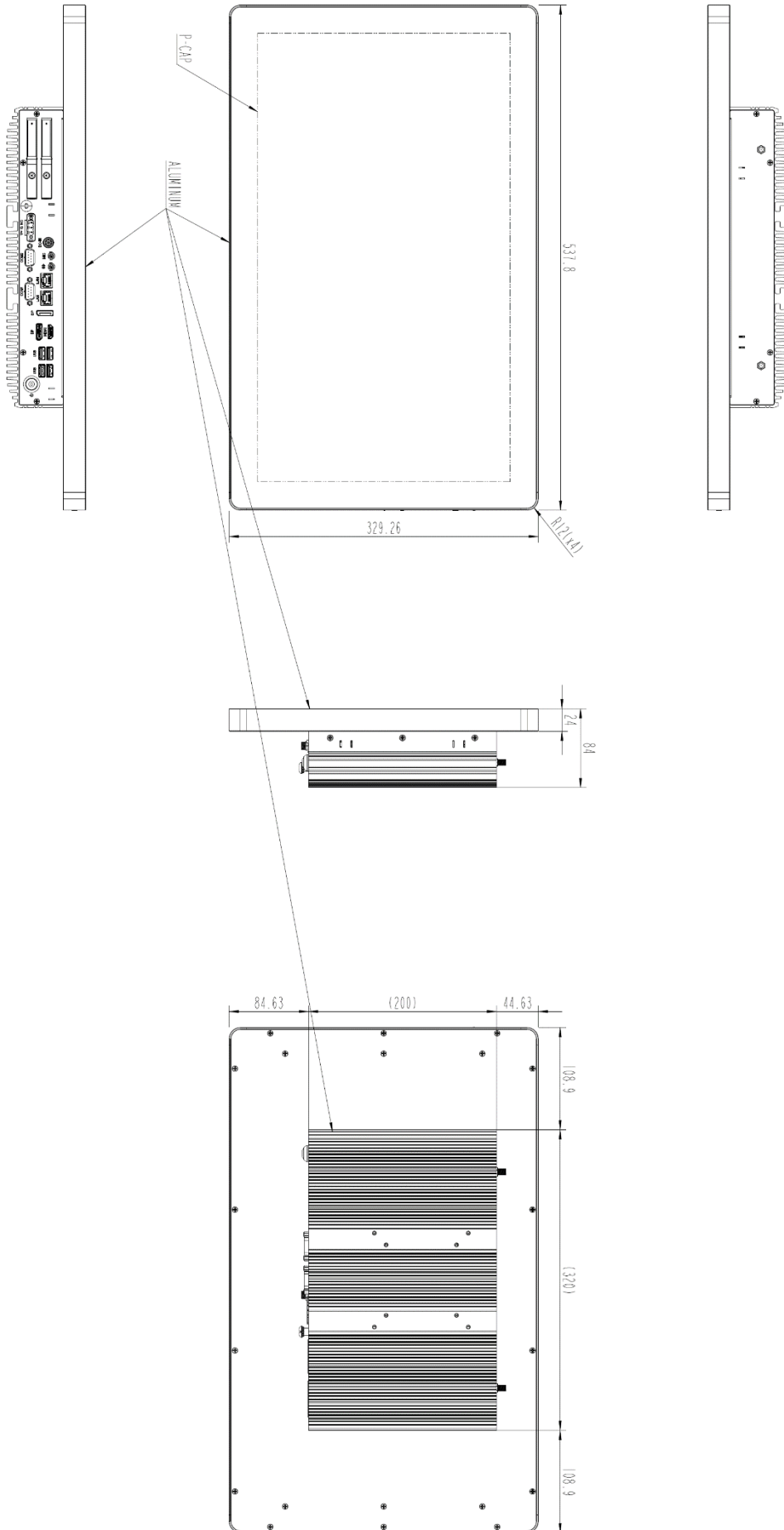

# 1.5 Top / Bottom IO View

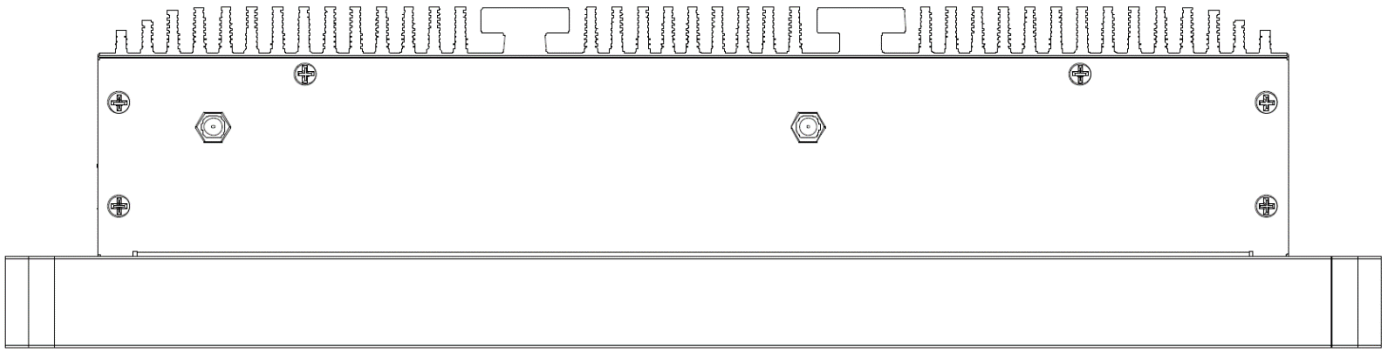

**Top View (by P150S)**

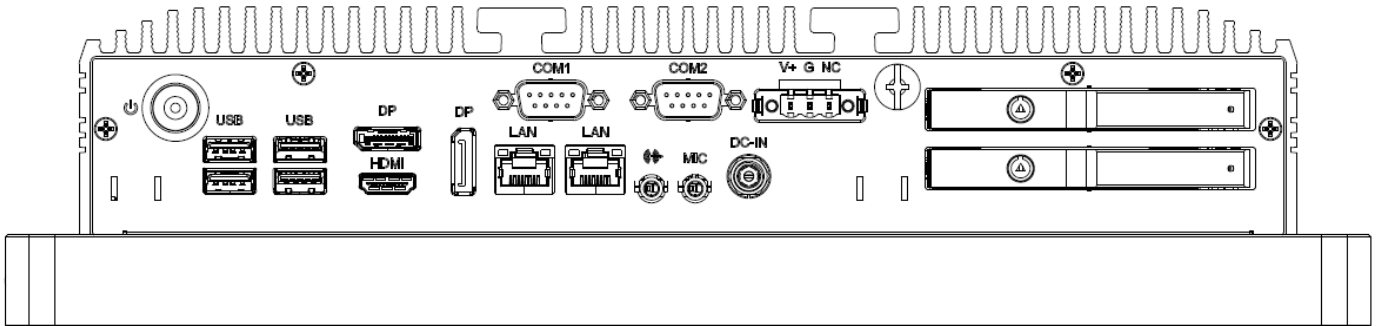

**Bottom View (by P150S)**

# 1.6 Motherboard Layout

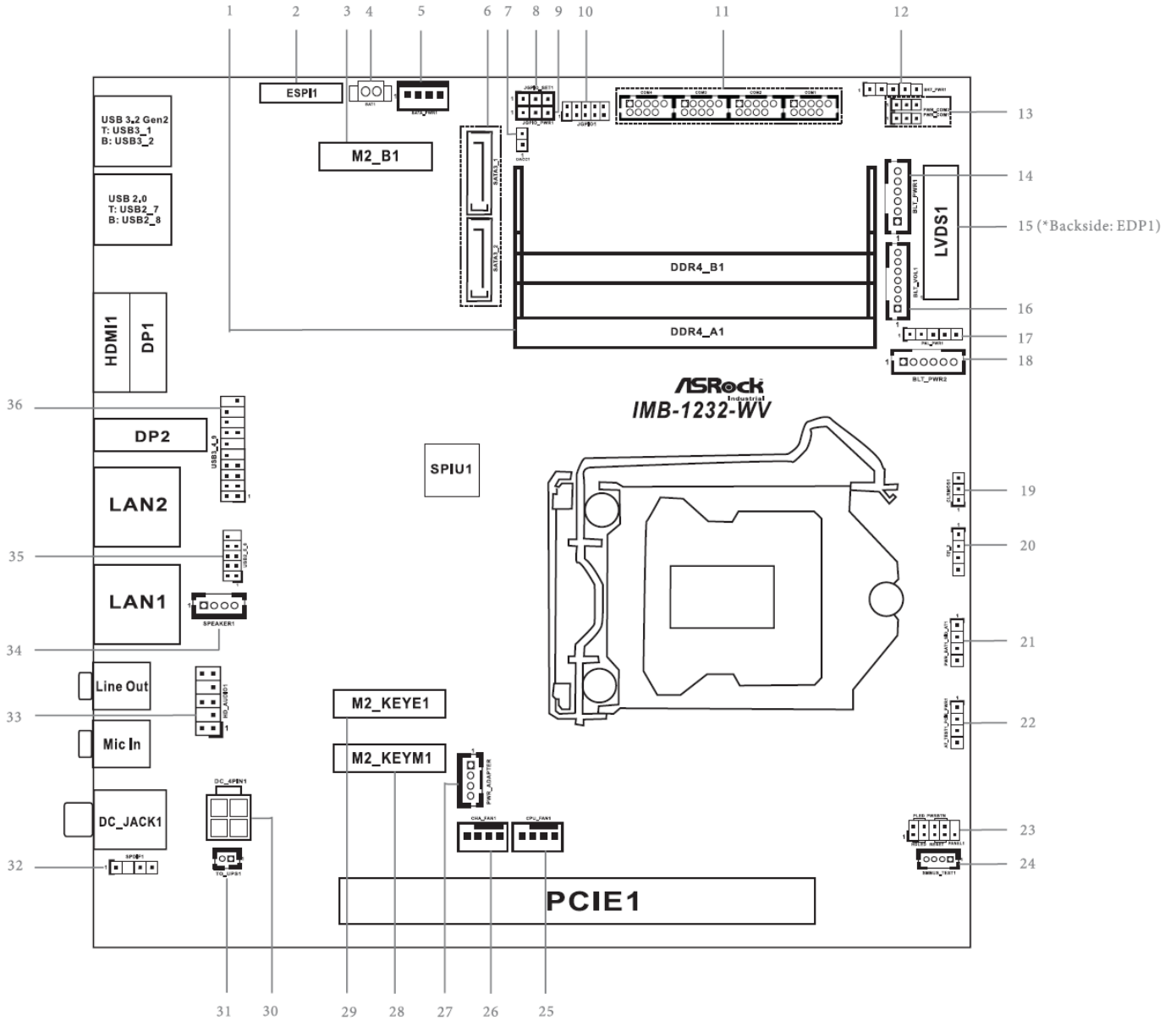

It may cause system/board damage if change the Jumper/Connector setting. Please do NOT change the setting if you are not very clear to know the Jumper/Connector used for.

- 1 : DDR4 SO-DIMM Sockets
- 2 : ESPI Header (ESPI1)
- 3 : M.2 Key-B Socket (M2\_B1)
- 4 : Battery Connector
- 5 : SATA Power Output Connector
- 6 : SATA3 Connectors (SATA3\_1, SATA3\_2)
- 7 : DAC1
- 8 : Digital Input / Output Default Value Setting (JGPIO\_SET1)
- 9 : Digital Input / Output Power Select (JGPIO\_PWR1)
- 10 : Digital Input/Output Pin Header (JGPIO1)
- 11 : COM Port Headers (COM1, 2, 3, 4)
- 12 : Backlight Power Select (LCD\_BLT\_VCC) (BKT\_PWR1)
- 13 : COM Port PWR Setting Jumpers  
PWR\_COM3 (For COM Port3)  
PWR\_COM1 (For COM Port1)
- 14 : Inverter Power Control Wafer (BLT\_PWR1)
- 15 : LVDS Panel Connector\*  
\* eDP Connector (on the Backside of PCB)
- 16 : Backlight Volume Control (BLT\_VOL1)
- 17 : Panel Power Select (LCD\_VCC) (PNL\_PWR1)
- 18 : Inverter Power Control Wafer (BLT\_PWR2)
- 19 : Clear CMOS Header (CLRMOS1)
- 20 : Chassis Intrusion Header (CI1\_2)
- 21 : PWR\_BAT1\_SIO\_AT1
- 22 : AT\_TEST1\_PCIE\_PWR1
- 23 : System Panel Header
- 24 : SMBUS\_TEST1
- 25 : CPU FAN Connector (+12V)
- 26 : Chassis FAN Connector (+12V)
- 27 : Power Adapter
- 28 : M.2 Key-M Socket (M2\_KEYM1)
- 29 : M.2 Key-E Socket (M2\_KEYE1)
- 30 : 4-pin ATX PWR Connector
- 31 : 2-pin UPS Module Power Input Connector
- 32 : SPDIF Header
- 33 : Front Panel Audio Header
- 34 : 3W Audio AMP Output Wafer
- 35 : USB2.0 Header (USB2\_5\_6)
- 36 : USB3.2 Gen1 Header (USB3\_4\_9)

# Chapter 2 Installation

The LPC 2AxM series is a panel-pc with Mini-ITX motherboard. Before you install the accessories on motherboard, study the installation guide to ensure that the accessories be secured.

## 2.1 Remove Heatsink

The heatsink cover is secured onto the chassis with 12 M3\*5 & 6 M3\*10 zinc-coated screws located at 4 sides. Use a Phillips screwdriver to unscrew them.

**Step 1.** Loosen screws as marked as below picture.

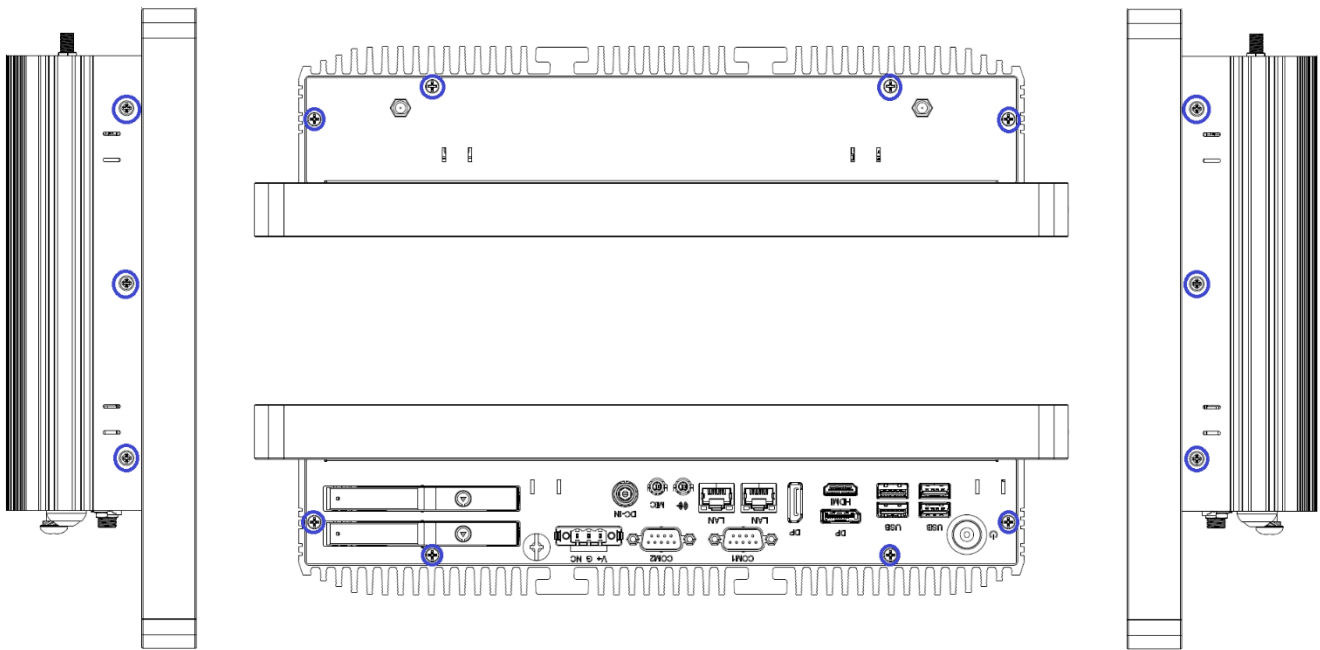

**Step 2.** Pull up the Heat-sink. It is heavy and hard to remove due to sticky by Thermal Pad. Please be careful and do not to hurt yourself or damage the system.

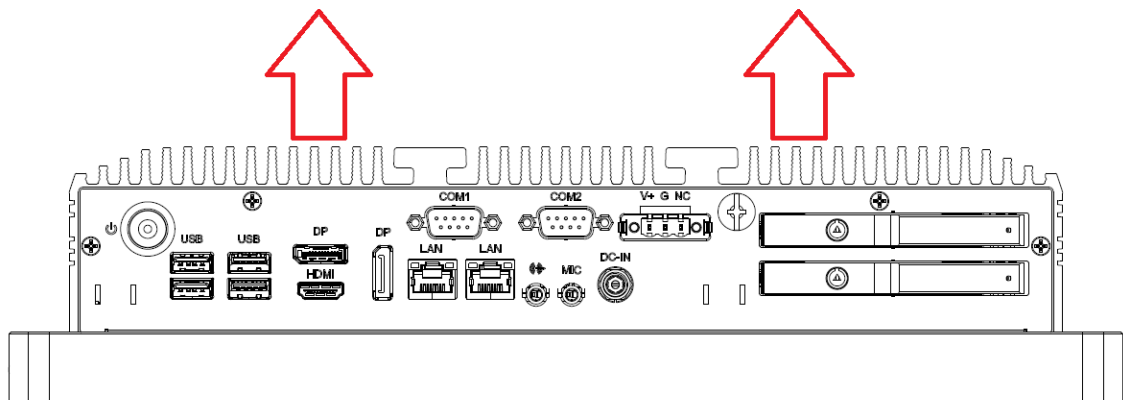

**Step 3.** You can access internal accessories while you pull the heatsink and Left/Right sides brackets.



1. Remove all power source before you start to remove heatsink.
2. It is easy to cause damage after the heatsink had removed. Please be carefully do not drop tools and/or parts on it while heatsink had removed.
3. Make sure all parts and screws are secured before you cover up.

## 2.2 Installation of DRAM

**Step 1.** Following CH2.1 to remove heatsink.

**Step 2.** Align a SO-DIMM on the slot such that the notch on the SO-DIMM matches the break on the slot.

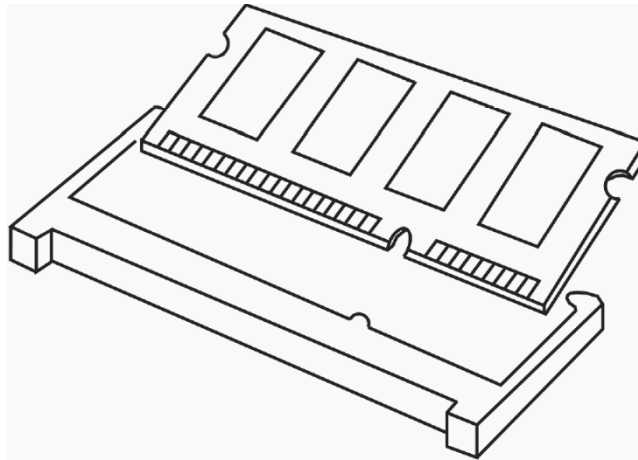

1. The SO-DIMM only fits in one correct orientation. It will cause permanent damage to the motherboard and the SO-DIMM if you force the SO-DIMM into the slot at incorrect orientation.
2. Please do not intermix different voltage SO-DIMMs on this motherboard.

**Step 3.** Firmly insert the SO-DIMM into the slot until the retaining clips at both ends fully snap back in place and the SO-DIMM is properly seated.



## 2.3 Installation of HDD (for 2AxM Series)

**Step 1.** Following CH2.1 to open case.

**Step 2.** Screwed Storage on bracket

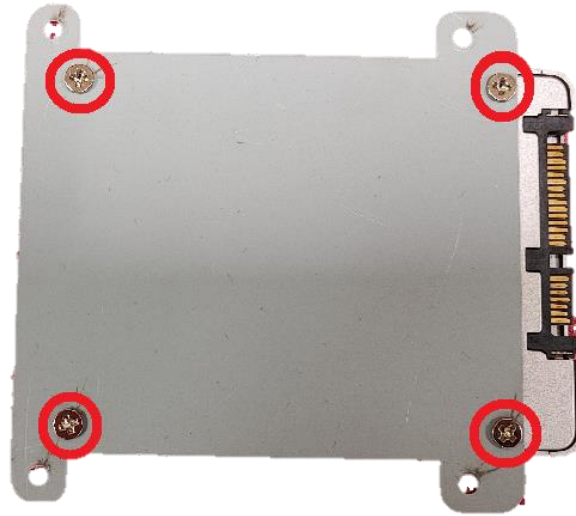

**Step 3.** Screwed the assembled parts of step2 into system



**Step 4.** Connect storage Cables with Boards

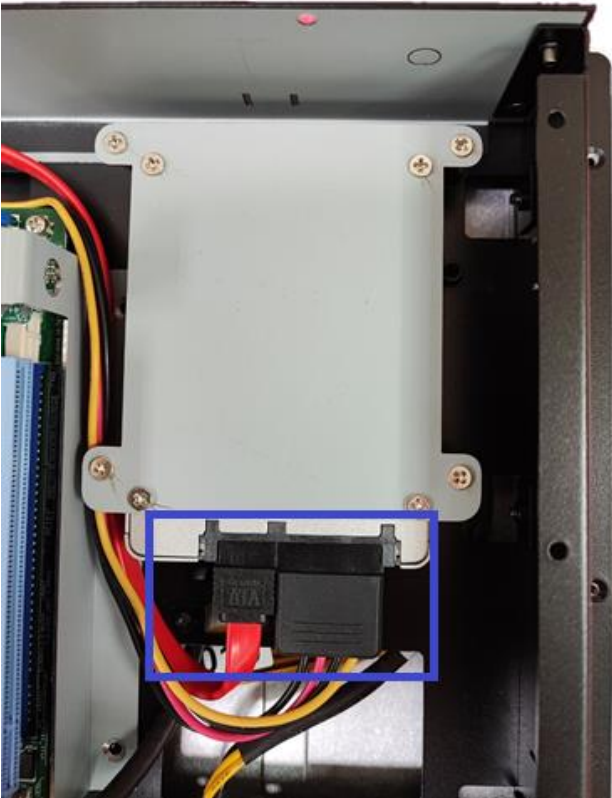

## 2.4 Installation of Low-Profile PCI-Express Cards (for 2AxM Series)

**Step 1.** Following CH2.1 to open case.

**Step 2.** Loosen screws to remove cover brackets.

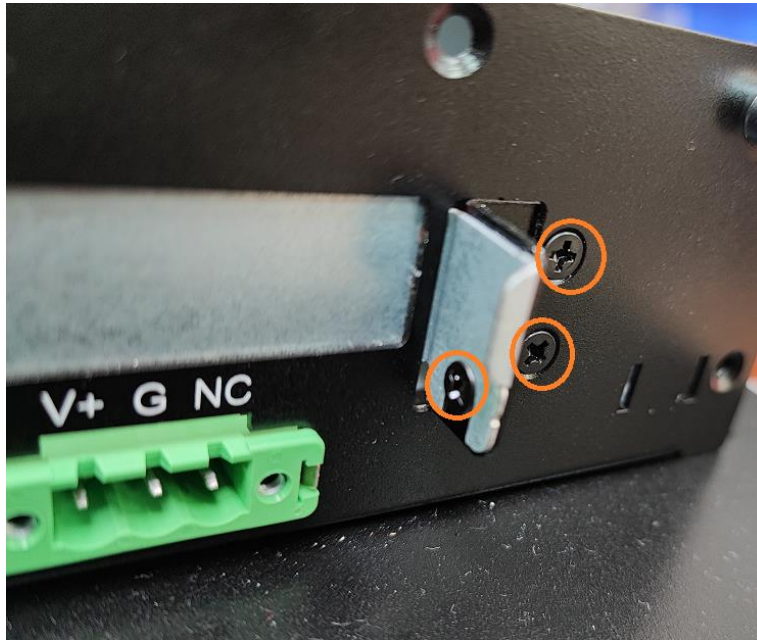

**Step 3.** Plug Low-Profile PCI-Express cards into slot.

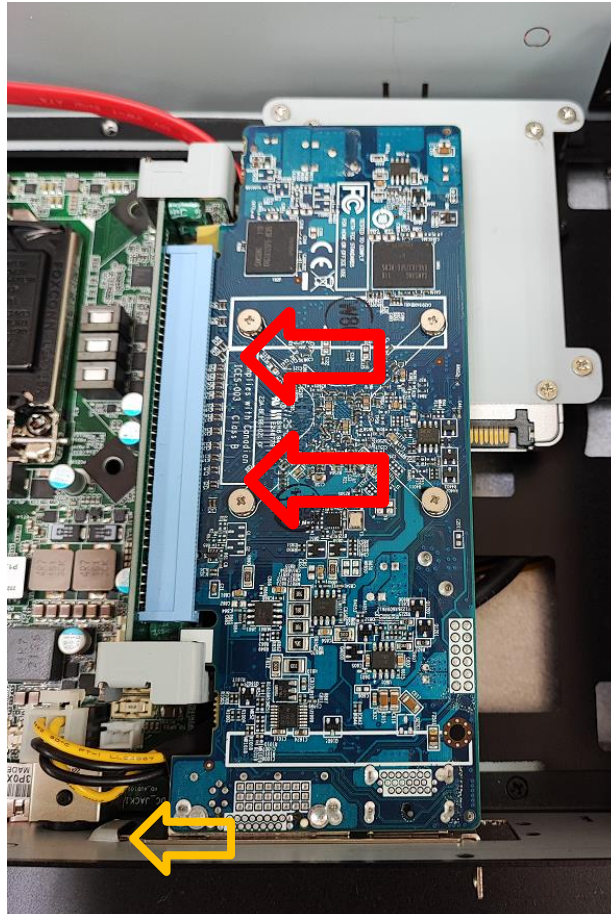

**Step 4.** Make sure the card's bracket had plugged into groove and screw in the three M3\*5 screws tight to secure the add-on cards.

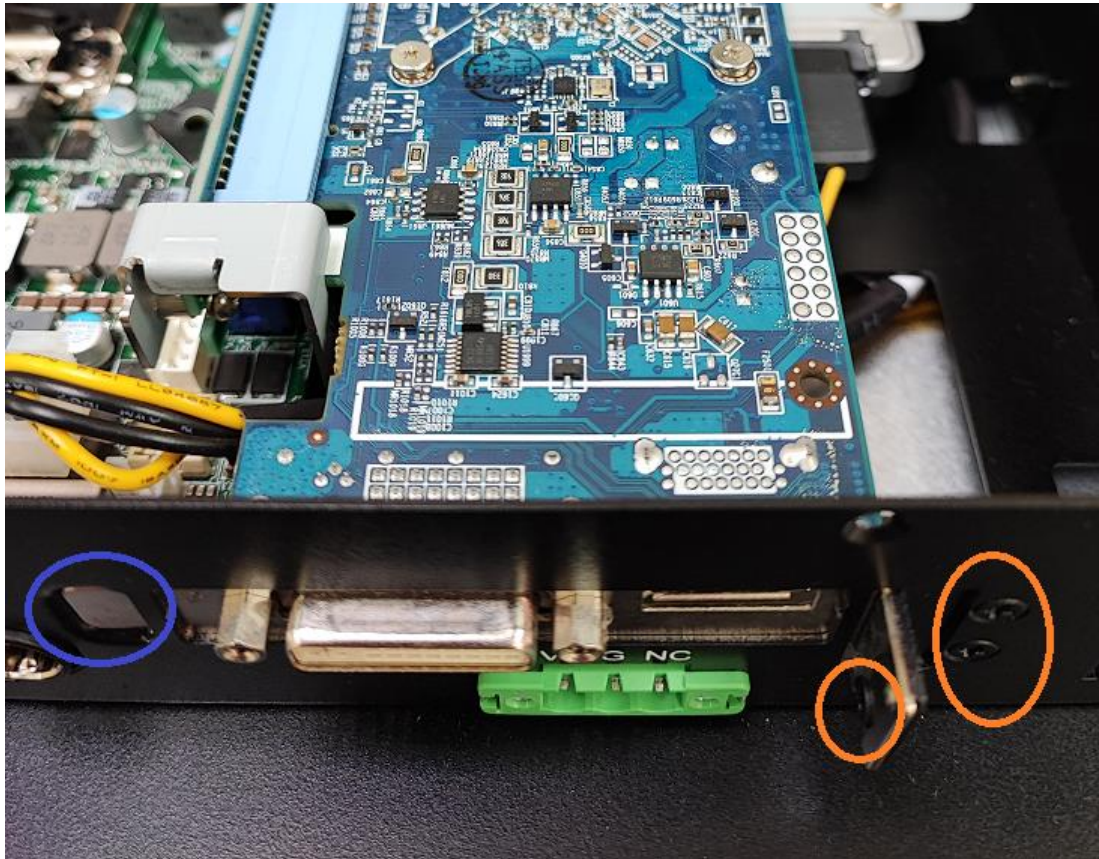

This section explains how to use the UEFI SETUP UTILITY (also names BIOS) to configure your system. The UEFI chip on the motherboard stores the UEFI SETUP UTILITY. You may run the UEFI SETUP UTILITY when you start up the computer. Please press

<F2> or <Del> during the Power-On-Self-Test (POST) to enter the UEFI SETUP UTILITY, otherwise, POST will continue with its test routines.

If you wish to enter the UEFI SETUP UTILITY after POST, restart the system by pressing <Ctl> + <Alt> + <Delete>, or by pressing the reset button on the system chassis. You may also restart by turning the system off and then back on.



Wrong Setting values in this section may cause the system malfunctions.

## 3.1 Entering and Control

Power on the computer and the system will start POST (Power-On Self-Test) process. When the message below appears on the screen, press <DEL> or <F2> key to enter Setup.

**Press <DEL> or <F2> to enter SETUP**

If the message disappears before you respond and you still wish to enter Setup, restart the system by turning it OFF and On or pressing the RESET button. You may also restart the system by simultaneously pressing <Ctrl>, <Alt>, and <Delete> keys.

### **Important**

The items under each BIOS category described in this chapter are under continuous update for better system performance. Therefore, the description may be slightly different from the latest BIOS and should be held for reference only.

### 3.1.1 UEFI Menu

**The top of the screen has a menu bar with the following selections:**

Main	To set up the system time/date information
Advanced	To set up the advanced UEFI features
H/W Monitor	To display current hardware status
Security	To set up the security features
Boot	To set up the default system device to locate and load the Operating System
Exit	To exit the current screen or the UEFI SETUP UTILITY

## 3.1.2 Control in UEFI

### Control Keys

← →	Select Screen
↑ ↓	Select Item
Enter	Select
+ -	Change Option
F1	General Help
F7	Previous Values
F9	Optimized Defaults
F10	Save & Restart
F12	Print screen
Esc	Exit

### Getting Help

After entering the Setup menu, the first menu you will see is the Main Menu.

### Main Menu

The main menu lists the setup functions you can make changes to. You can use the arrow keys ( ↑↓ ) to select the item. The on-line description of the highlighted setup function is displayed at the bottom of the screen.

### Sub-Menu

If you find a right pointer symbol appears to the left of certain fields that means a sub-menu can be launched from this field. A sub-menu contains additional options for a field parameter. You can use arrow keys ( ↑↓ ) to highlight the field and press <Enter> to call up the sub-menu. Then you can use the control keys to enter values and move from field to field within a sub-menu. If you want to return to the main menu, just press the <Esc >.

### General Help <F1>

The BIOS setup program provides a General Help screen. You can call up this screen from any menu by simply pressing <F1>. The Help screen lists the appropriate keys to use and the possible selections for the highlighted item. Press <Esc> to exit the Help screen.

## 3.2 Main

When you enter the UEFI SETUP UTILITY, the Main screen will appear and display the system overview.

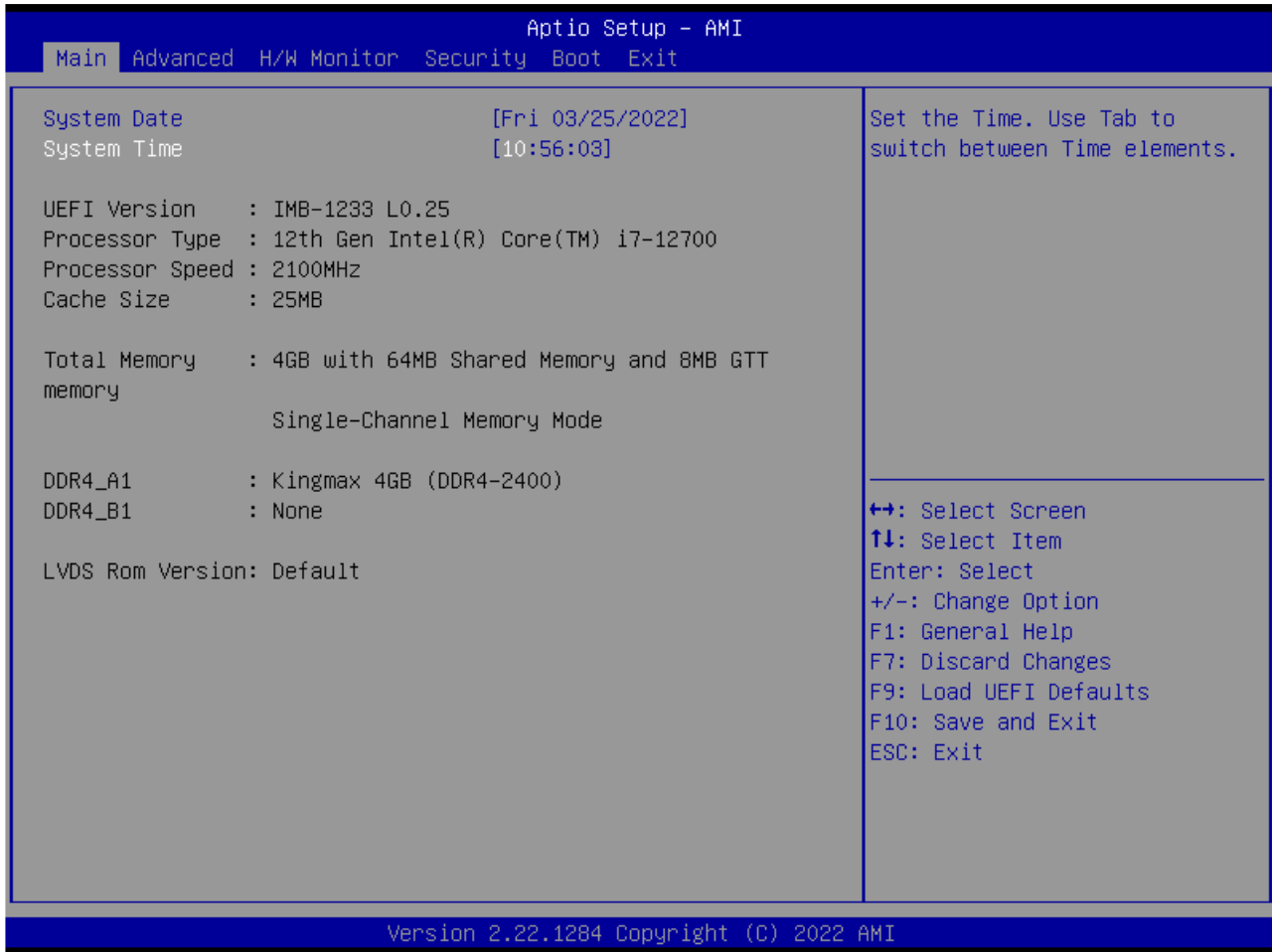

### System Date

This setting allows you to set the system date.

The date format is <Day>, <Month> / <Date> / <Year>.

### System Time

This setting allows you to set the system time.

The time format is <Hour> / <Minute> / <Second>.

## 3.3 Advanced

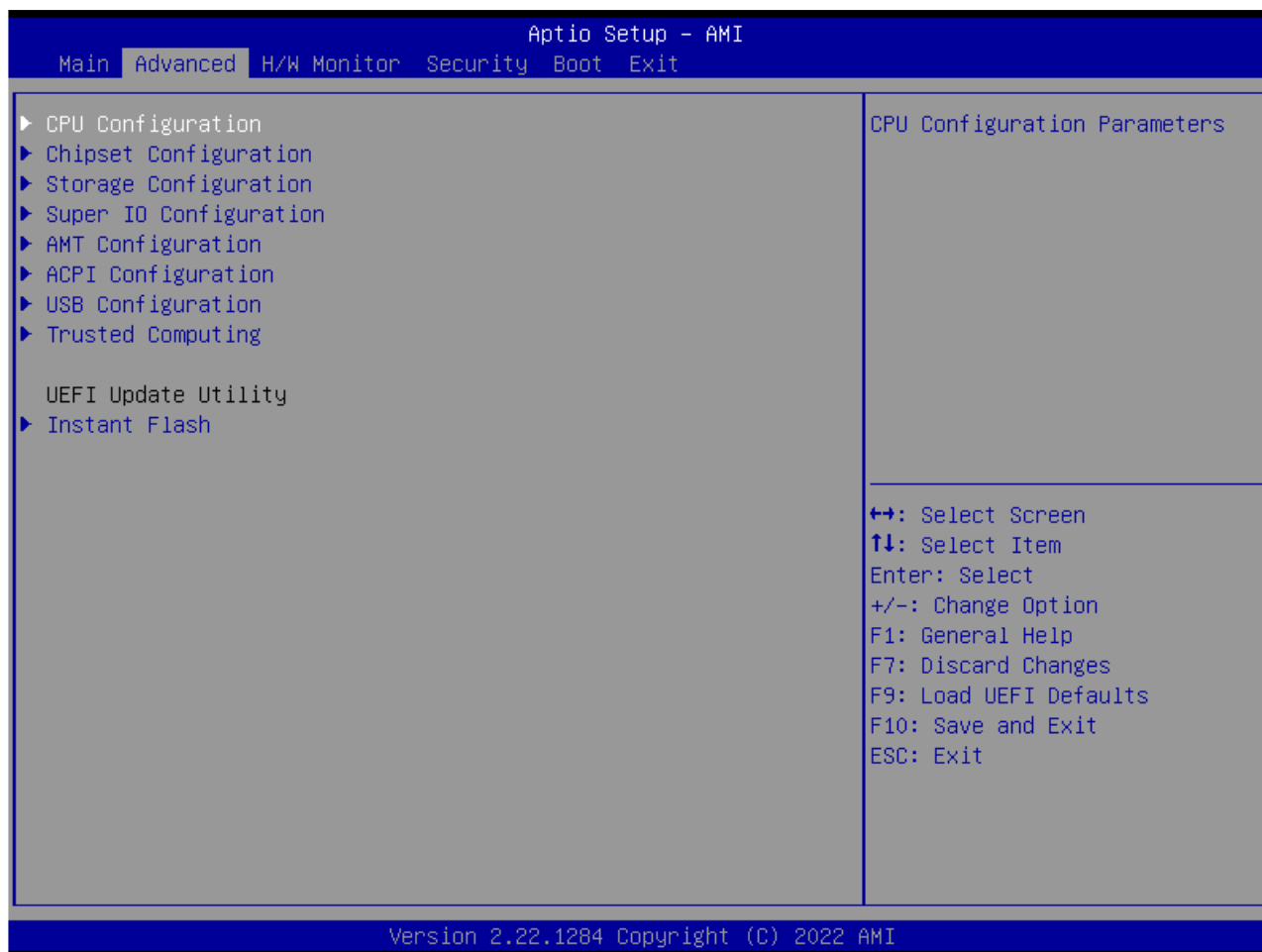

### Instant Flash

Instant Flash is a UEFI flash utility embedded in Flash ROM. This convenient UEFI update tool allows you to update system UEFI BIOS without entering operating systems first like MS-DOS or Windows®. Just launch this tool and save the new UEFI BIOS file to your USB flash drive, floppy disk or hard drive, then you can update your UEFI only in a few clicks without preparing an additional floppy diskette or other complicated flash utility. Please be noted that the USB flash drive or hard drive must use FAT32/16/12 file system. If you execute Instant Flash utility, the utility will show the UEFI files and their respective information. Select the proper UEFI file to update your UEFI BIOS and reboot your system after UEFI update process completes.



### 3.3.1 CPU Configuration

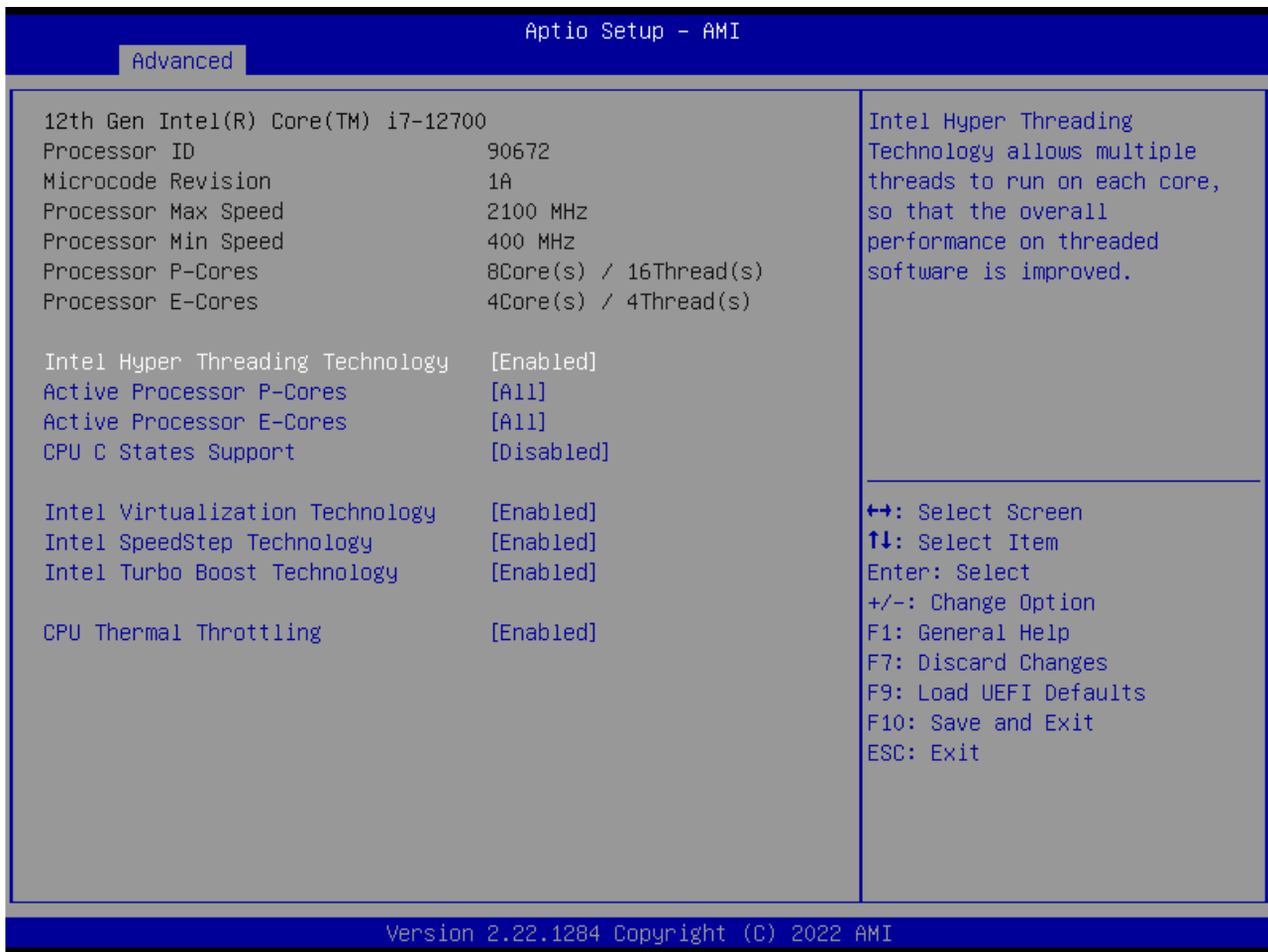

Please note that enabling this function may reduce CPU voltage and lead to system stability or compatibility issues with some power supplies. Please set this item to [Disabled] if above issues occur.

#### Intel Hyper Threading Technology

Intel Hyper Threading Technology allows multiple threads to run on each core, so that the overall performance on threaded software is improved.

#### Active Processor Cores

Select the number of cores to enable in each processor package.

#### CPU C States Support

Enable CPU C States Support for power saving. It is recommended to keep C3, C6 and C7 all enabled for better power saving.

#### Intel Virtualization Technology

When this option is set to [Enabled], a VMM (Virtual Machine Architecture) can utilize the additional hardware capabilities provided by Vanderpool Technology. This option will be hidden if the installed CPU does not support Intel Virtualization Technology.

#### Intel SpeedStep

Intel SpeedStep technology is Intel's new power saving technology. Processors can switch between multiple frequencies and voltage points to enable power saving.

The default value is [Enabled]. Configuration options: [Enabled] and [Disabled].

If you install Windows® OS and want to enable this function, please set this item to [Enabled]. This item will be hidden if the current CPU does not support Intel SpeedStep technology.

### **Intel Turbo Boost Technology**

Use this item to enable or disable Intel Turbo Boost Mode Technology.

Turbo Boost Mode allows processor cores to run faster than marked frequency in specific conditions.

The default value is [Enabled].

### **CPU Thermal Throttling**

You may select [Enabled] to enable CPU internal thermal control mechanism to keep the CPU from overheating.

### **Hardware Prefetcher**

Use this item to turn on/off the MLC streamer prefetcher.

### **Adjacent Cache Line Prefetch**

Use this item to turn on/off prefetching of adjacent cache lines.

## 3.3.2 Chipset Configuration

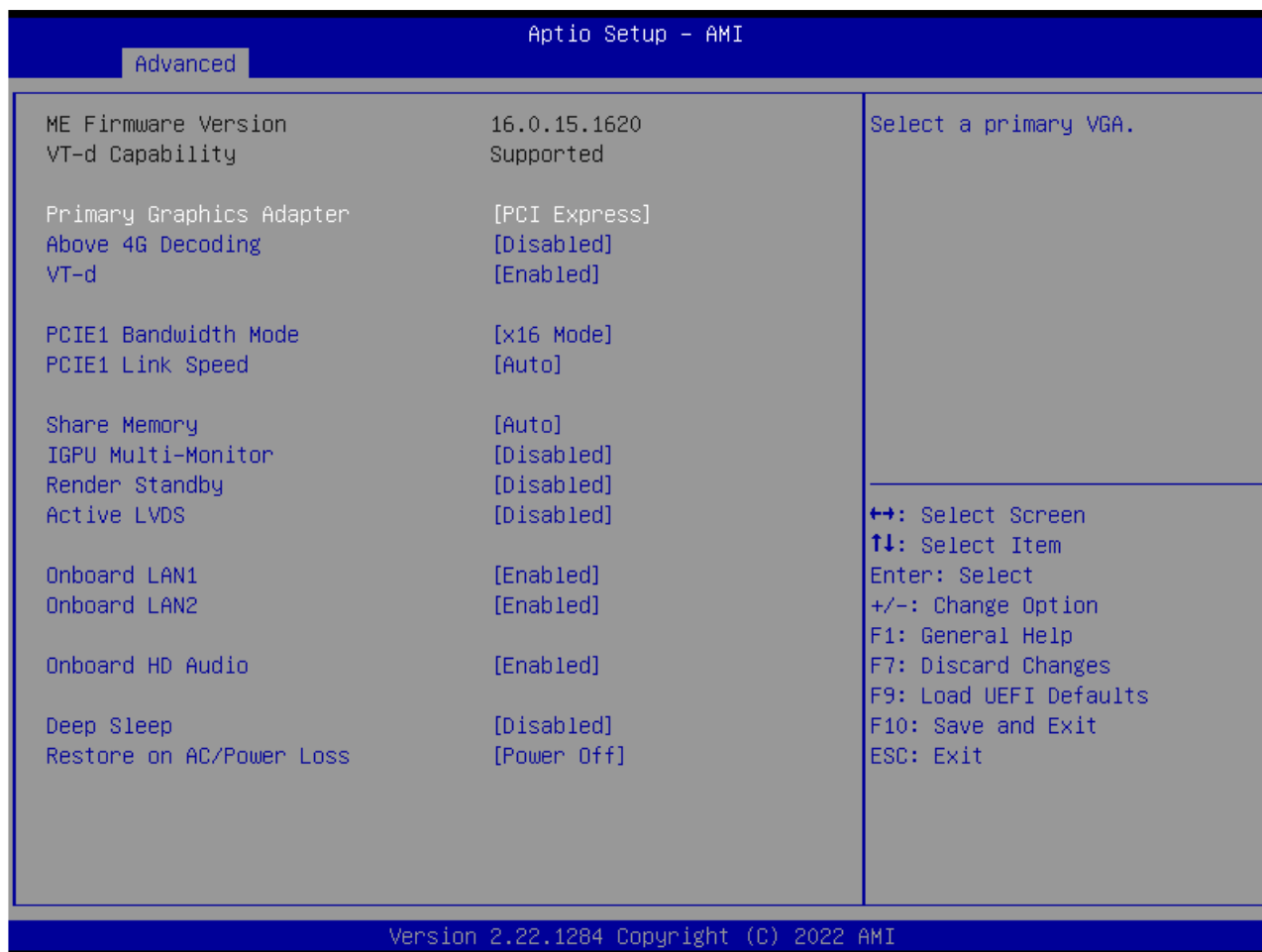

### Primary Graphics Adapter

This allows you to select [Onboard] or [PCI Express] as the boot graphic adapter priority. The default value is [PCI Express].

### Above 4G Decoding

Enable or disable 64bit capable Devices to be decoded in Above 4G Address Space (only if the system supports 64 bit PCI decoding).

### VT-d

Use this to enable or disable Intel® VT-d technology (Intel® Virtualization Technology for Directed I/O).

The default value of this feature is [Disabled].

### PCIE1 Link Speed

Select the link speed for PCIE1.

### PCIE1 Bandwidth Mode

Select the bandwidth mode for PCIE1.

### Share Memory

Configure the size of memory that is allocated to the integrated graphics processor when the system boots up.

### IGPU Multi-Monitor

Select disable to disable the integrated graphics when an external graphics card is installed.  
Select enable to keep the integrated graphics be enabled at all times.

### **Active LVDS**

Use this to enable or disable the LVDS. The default value is [Disabled].

Set the item to [enable]. Then press <F10> to save the setting and restart the system. Now the default value of Active LVDS is changed to ENABLE (F9 load default is also set to ENABLE)

Change the setting from [Enable] to [Disable], and then press <F10> to save the setting and restart the system. Likewise, the default value of Active LVDS is changed to DISABLE (F9 load default is also set to DISABLE)

### **Panel Type Selection**

Use this to select panel type. This item appears when you enable Active LVDS.



Please do not change the Active LVDS and Panel Type Selection value to avoid the no display issue.

### **Onboard LAN1**

This allows you to enable or disable the Onboard LAN1 feature.

### **Onboard LAN2**

This allows you to enable or disable the Onboard LAN2 feature.

### **Onboard HD Audio**

Select [Auto], [Enabled] or [Disabled] for the onboard HD Audio feature. If you select [Auto], the onboard HD Audio will be disabled when PCI Sound Card is plugged.

### **Front Panel**

Select [HD] or [AC 97] for the onboard HD Audio Front Panel.

### **Onboard Digital Audio**

Enable or disable Onboard Digital Audio.

### **Deep Sleep**

Mobile platforms support Deep S4/S5 in DC only and desktop platforms support Deep S4/S5 in AC only. The default value is [Disabled].

### 3.3.3 Storage Configuration

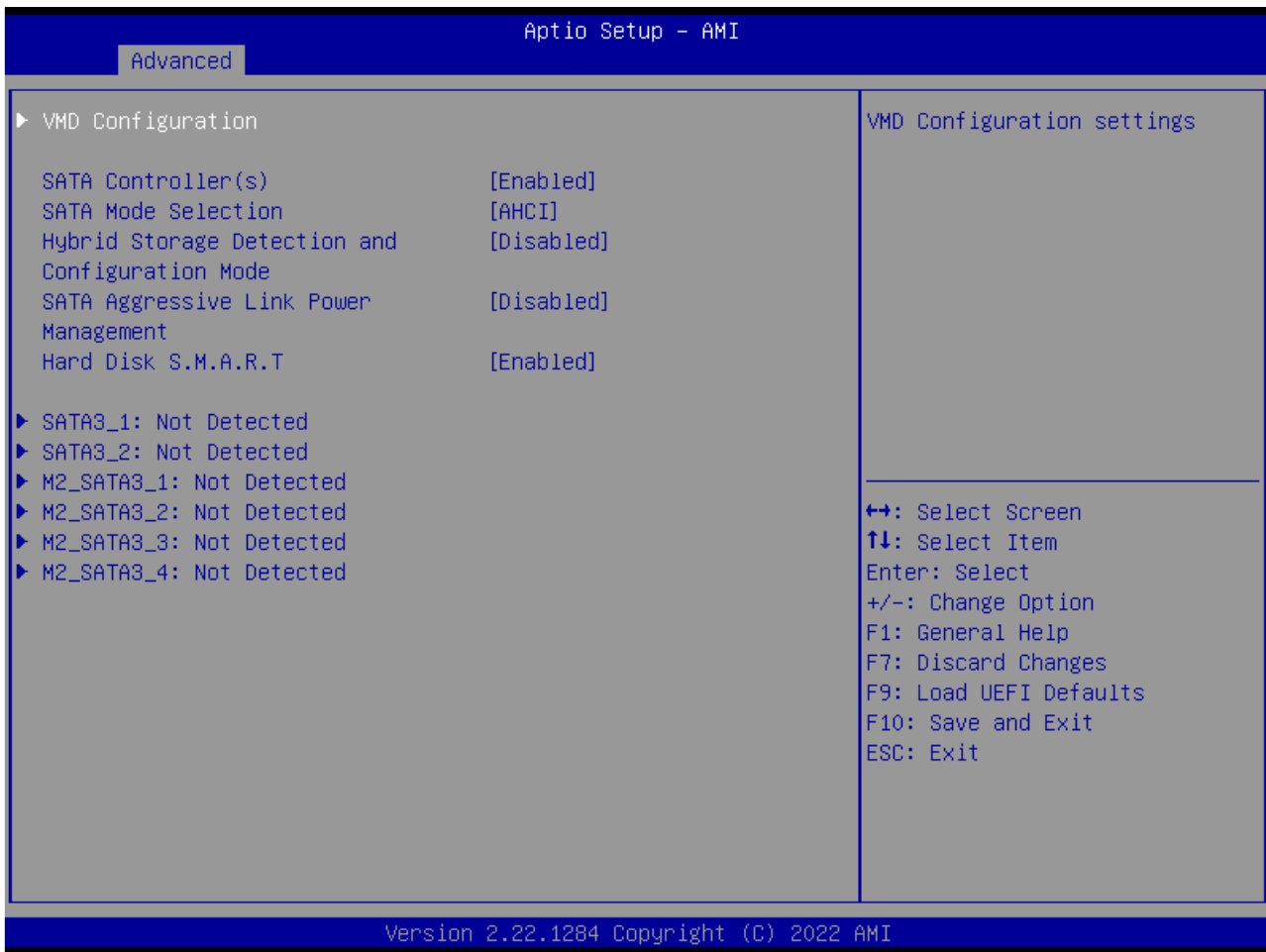

#### VMD Configuration

This item allows you to enable or disable the Intel VMD support function.

#### SATA Controller(s)

Use this item to enable or disable the SATA Controller feature.

#### SATA Mode Selection

Use this to select SATA mode. The default value is [AHCI Mode].



AHCI (Advanced Host Controller Interface) supports NCQ and other new features that will improve SATA disk performance, but IDE mode does not have these advantages.

#### Hybrid Storage Detection and Configuration Mode

Use this item to enable or disable Hybrid Storage Detection and Configuration Mode.

#### SATA Aggressive Link Power Management

Use this item to configure SATA Aggressive Link Power Management.

#### Hard Disk S.M.A.R.T.

Use this item to enable or disable the S.M.A.R.T. (Self-Monitoring, Analysis, and Reporting Technology) feature. Configuration options: [Disabled] and [Enabled].

### 3.3.4 Super IO Configuration

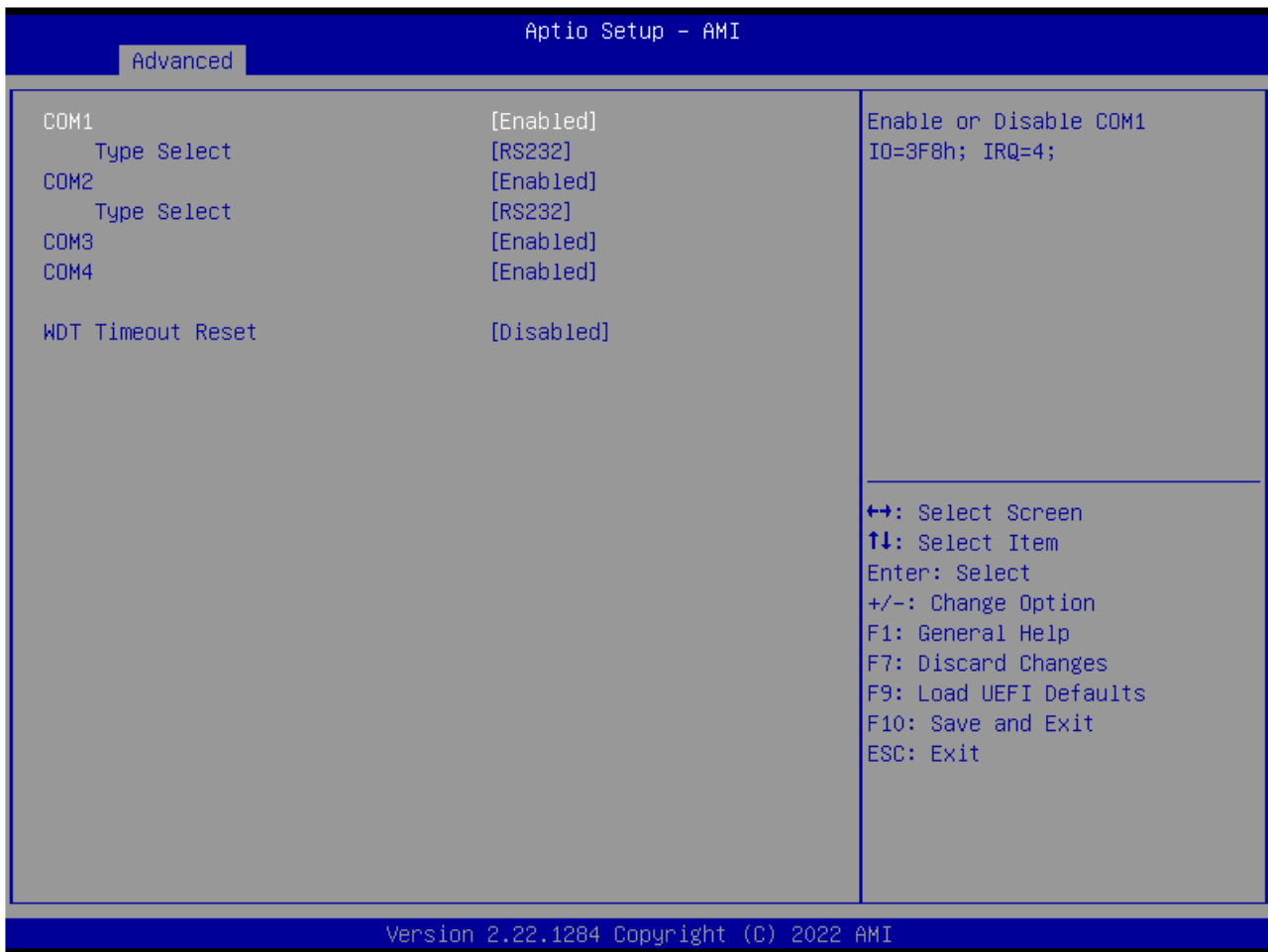

#### COM1 Configuration

Use this to set parameters of COM1.

#### Type Select

Use this to select COM3 port type: [RS232], [RS422] or [RS485].

#### COM2 Configuration

Use this to set parameters of COM2.

#### Type Select

Use this to select COM3 port type: [RS232], [RS422] or [RS485].

#### COM3 Configuration

Use this to set parameters of COM3.

#### COM4 Configuration

Use this to set parameters of COM4.

#### WDT Timeout Reset

Use this to set the Watch Dog Timer.

### 3.3.5 ACPI Configuration

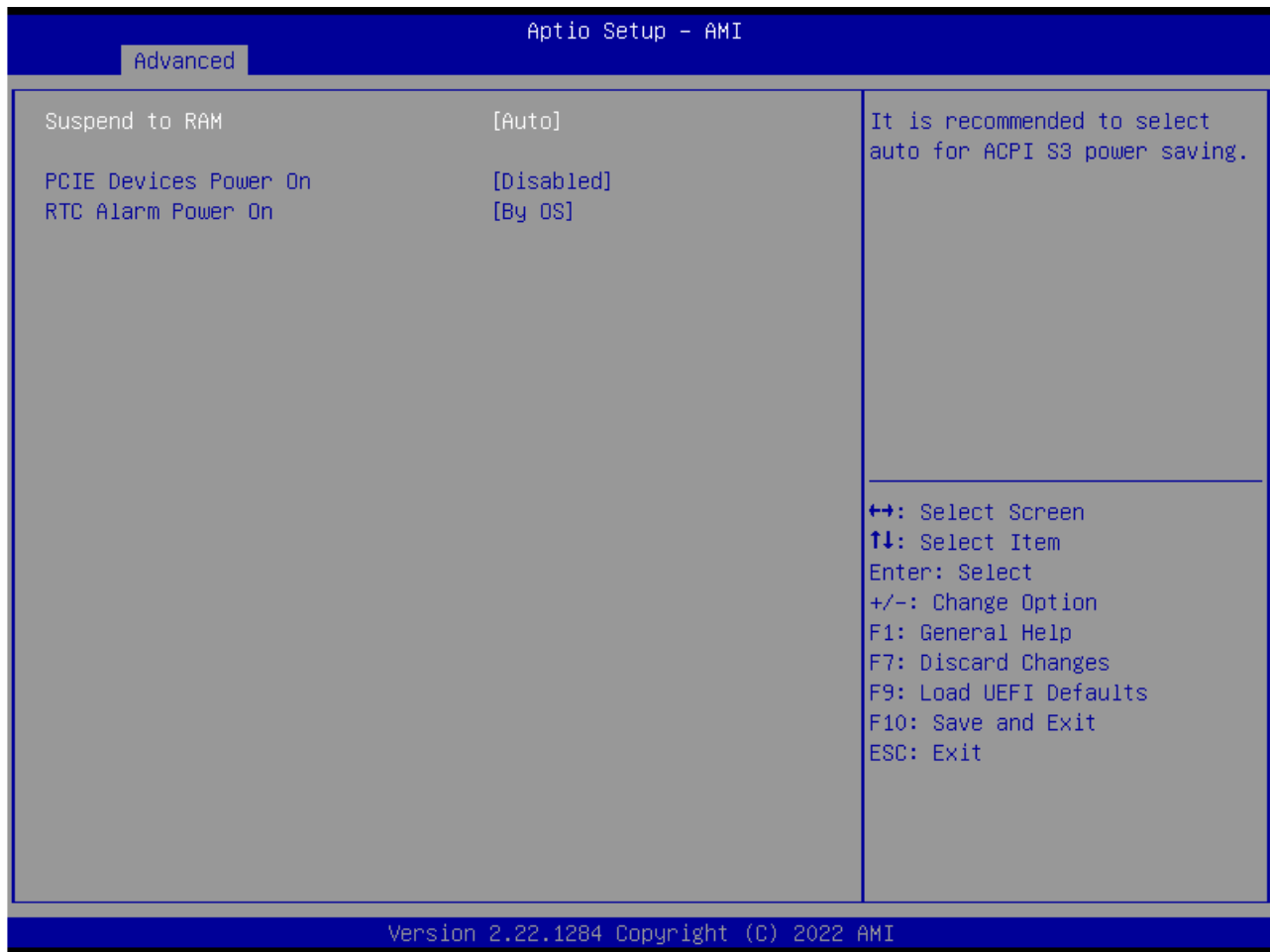

#### **Suspend to RAM**

Use this item to select whether to auto-detect or disable the Suspend-to-RAM feature. Select [Auto] will enable this feature if the OS supports it.

#### **PCIE Devices Power On**

Use this item to enable or disable PCIE devices to turn on the system from the power-soft-off mode.

#### **RTC Alarm Power On**

Use this item to enable or disable RTC (Real Time Clock) to power on the system.

### 3.3.6 USB Configuration

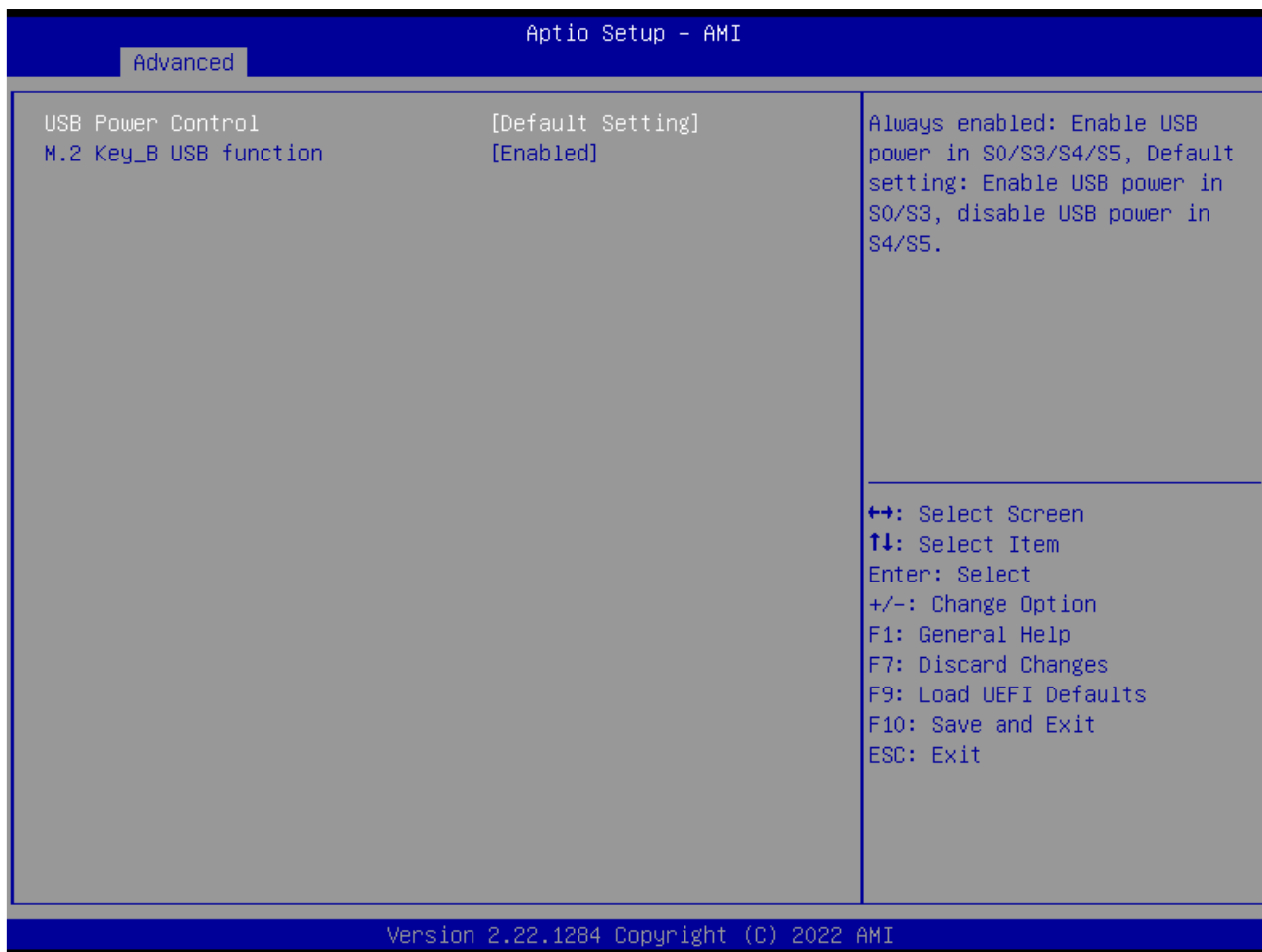

#### USB Power Control

Use this option to control USB power.

#### M.2 Key\_B USB Configuration

Enable or disable M.2 Key\_B USB Configuration.



### 3.3.7 Trusted Computing

Aptio Setup - AMI		
Advanced		
TPM 2.0 Device Found		Enables or Disables BIOS support for security device. O.S. will not show Security Device. TCG EFI protocol and INT1A interface will not be available.
Firmware Version:	7.85	
Vendor:	IFX	
Security Device Support	[Enable]	
Active PCR banks	SHA256	
Available PCR banks	SHA256	
SHA256 PCR Bank	[Enabled]	
Pending operation	[None]	
Platform Hierarchy	[Enabled]	
Storage Hierarchy	[Enabled]	
Endorsement Hierarchy	[Enabled]	←→: Select Screen ↑↓: Select Item Enter: Select +/-: Change Option F1: General Help F7: Discard Changes F9: Load UEFI Defaults F10: Save and Exit ESC: Exit
Physical Presence Spec Version	[1.3]	
TPM 2.0 InterfaceType	[TIS]	
Device Select	[Auto]	
Onboard TPM	[Enabled]	

Version 2.22.1284 Copyright (C) 2022 AMI

#### Security Device Support

Enable or disable BIOS support for security device.

## 3.4 Hardware Health Event Monitoring Screen

In this section, it allows you to monitor the status of the hardware on your system, including the parameters of the CPU temperature, motherboard temperature, CPU fan speed, chassis fan speed, and the critical voltage.

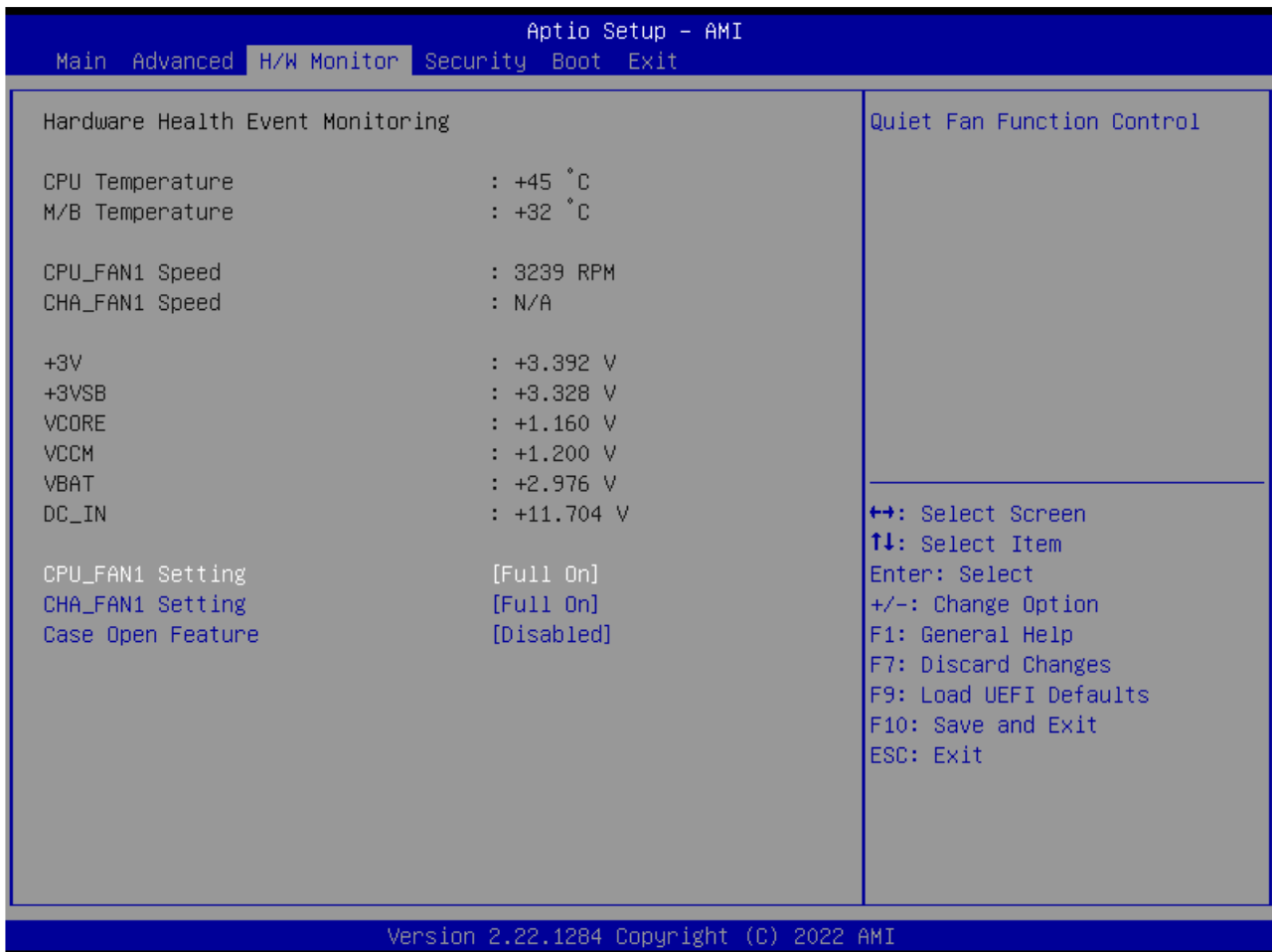

### CPU\_FAN1 Setting

This allows you to set CPU fan 1's speed. Configuration options: [Full On] and [Automatic Mode]. The default value is [Full On].

### CHA\_FAN1 Setting

This allows you to set chassis fan 1's speed. Configuration options: [Full On] and [Automatic Mode]. The default value is [Full On].

### Case Open Feature

This allows you to enable or disable case open detection feature. The default is value [Disabled].

### Clear Status

This option appears only when the case open has been detected. Use this option to keep or clear the record of previous chassis intrusion status.

## 3.5 Security

In this section, you may set, changes or clear the supervisor/user password for the system.

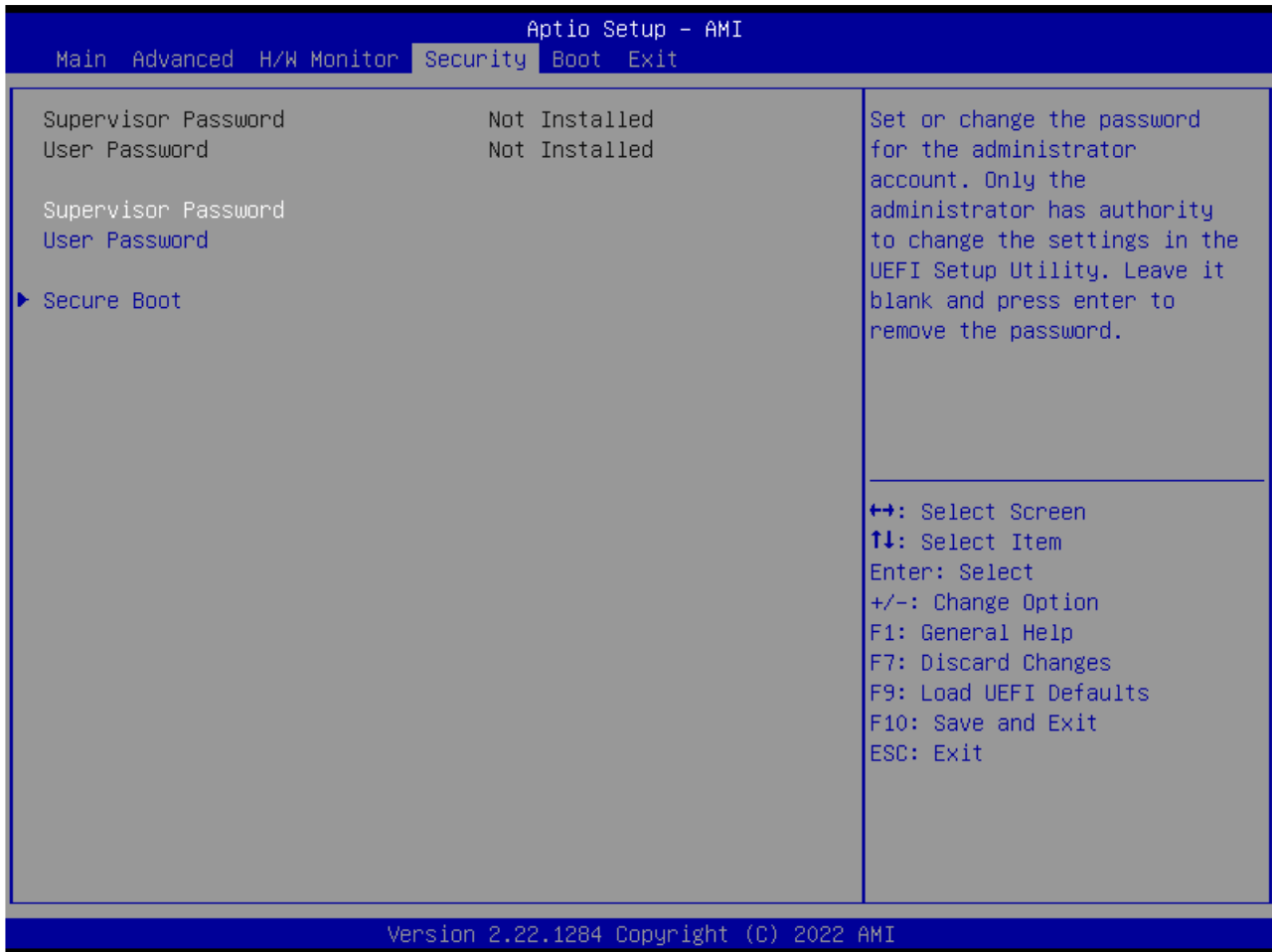

### Supervisor Password

Set or change the password for the administrator account. Only the administrator has authority to change the settings in the UEFI Setup Utility. Leave it blank and press enter to remove the password.

### User Password

Set or change the password for the user account. Users are unable to change the settings in the UEFI Setup Utility. Leave it blank and press enter to remove the password.

### Secure Boot

Use this item to enable or disable support for Secure Boot.

## 3.6 Boot

In this section, it will display the available devices on your system for you to configure the boot settings and the boot priority.

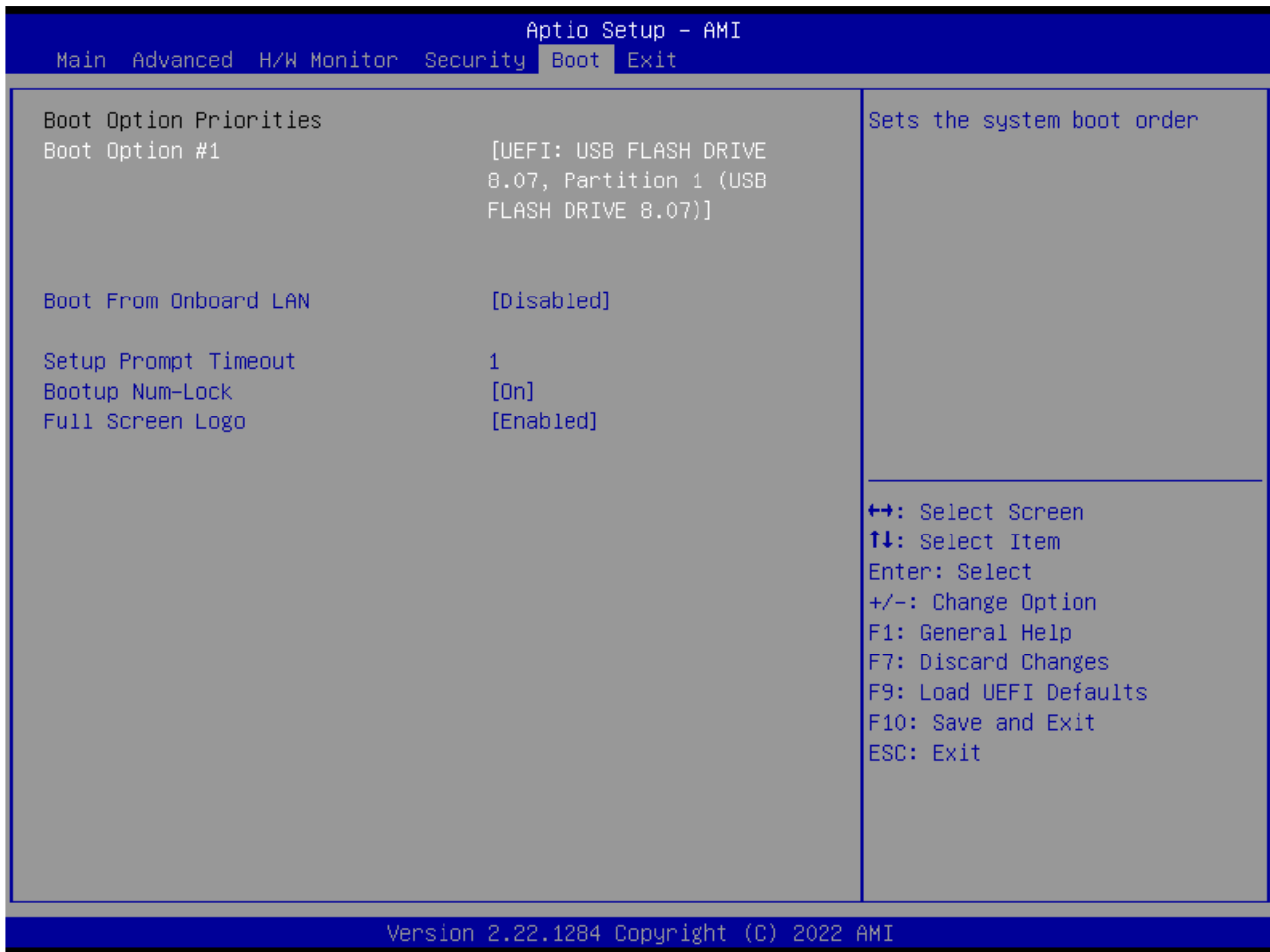

### Boot From Onboard LAN

Use this item to enable or disable the Boot From Onboard LAN feature.

### Setup Prompt Timeout

This shows the number of seconds to wait for setup activation key. 65535(0XFFFF) means indefinite waiting.

### Bootup Num-Lock

If this item is set to [On], it will automatically activate the Numeric Lock function after boot-up.

### Full Screen Logo

Use this item to enable or disable OEM Logo. The default value is [Disabled].

## 3.7 Exit



### Save Changes and Exit

When you select this option, it will pop-out the following message, “Save configuration changes and exit setup?” Select [OK] to save the changes and exit the UEFI SETUP UTILITY.

### Discard Changes and Exit

When you select this option, it will pop-out the following message, “Discard changes and exit setup?” Select [OK] to exit the UEFI SETUP UTILITY without saving any changes.

### Discard Changes

When you select this option, it will pop-out the following message, “Discard changes?” Select [OK] to discard all changes.

### Load UEFI Defaults

Load UEFI default values for all the setup questions. F9 key can be used for this operation.

### Launch EFI Shell from filesystem device

Attempts to Launch EFI Shell application (Shell64.efi) from one of the available filesystem devices.

# Chapter 4 Installation Drivers

The system supports various Microsoft® Windows® operating systems: 11 64bit / 10 64bit. Because motherboard settings and hardware options vary, use the setup procedures in this chapter for general reference only. Refer your OS documentation for more information.

## 4.1 Chipset Driver Installation

**4.1.1 Select “Chipset-10.1.19165.8332-Public-MUP” folder and execute “SetupChipset.exe”**

**4.1.2 Please follow the red blank.**









## 4.2 Graphics Driver Setup

4.2.1 Select “ Intel\_VGA(v31.0.101.4146)” folder and execute  
“GFX\_win\_101.4146.exe”

4.2.2 Please follow the red blank.



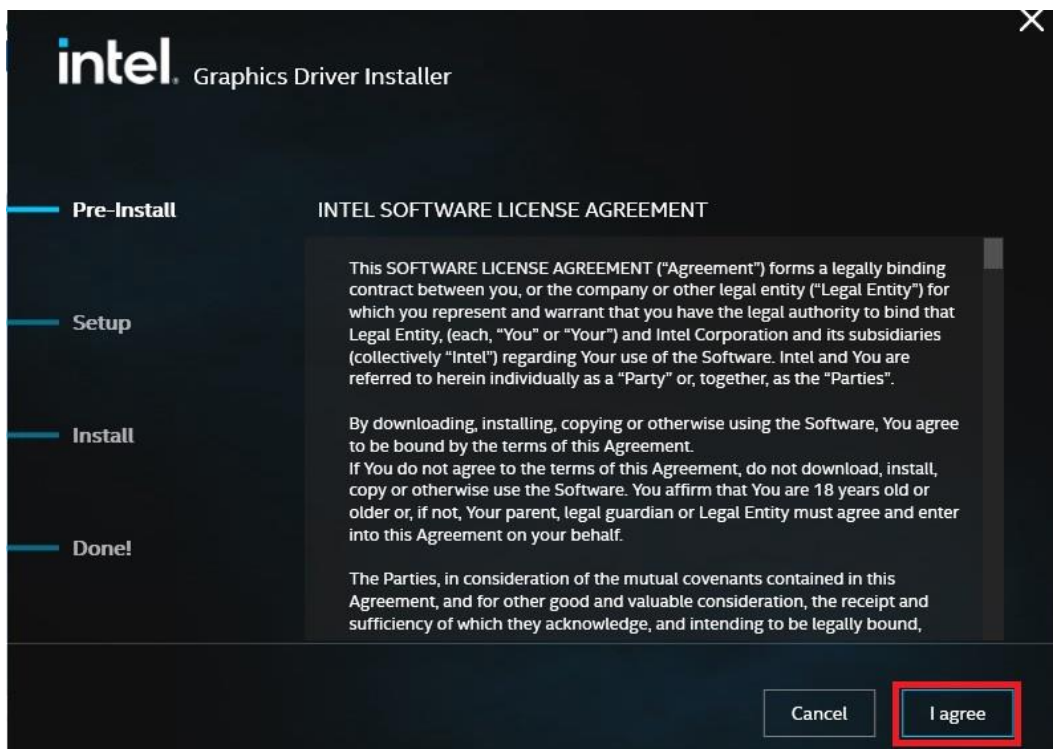

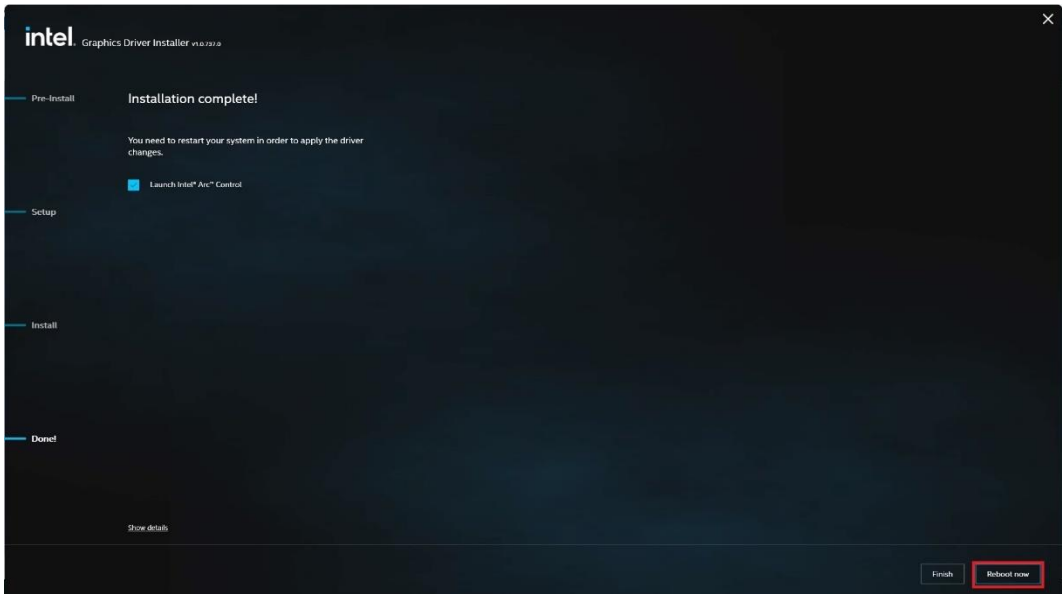
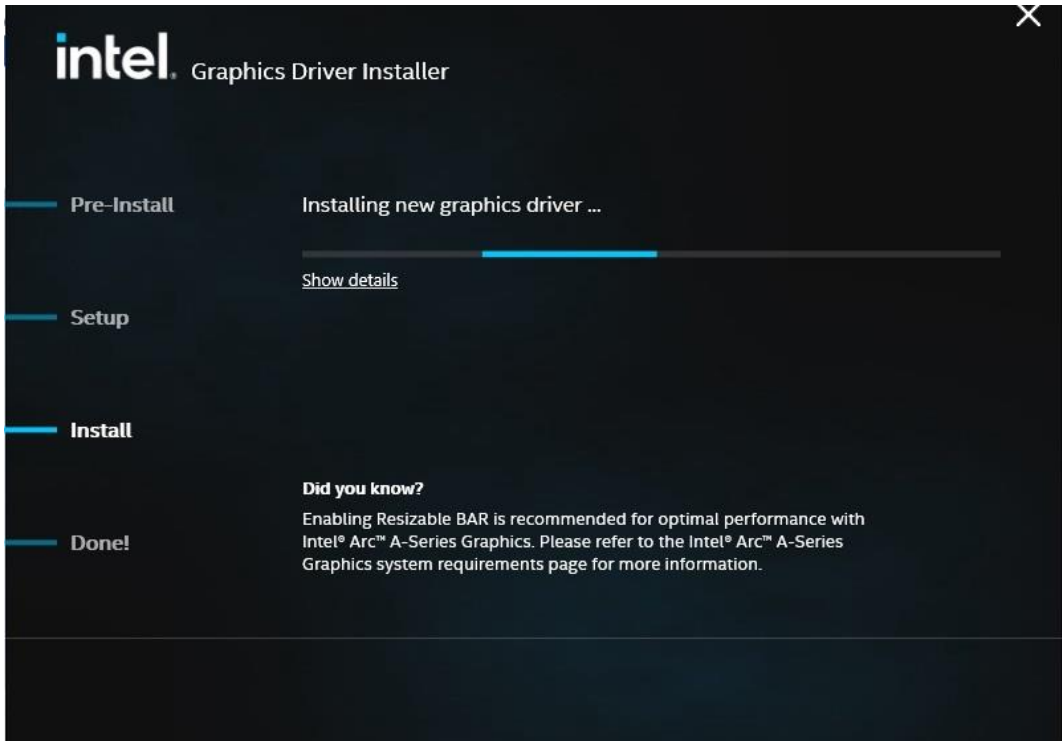

## 4.3 Audio Driver Setup

4.3.1 Select “Audio(9239\_FF00)” folder and execute “Setup.exe”

4.3.2 Please follow the red blank.

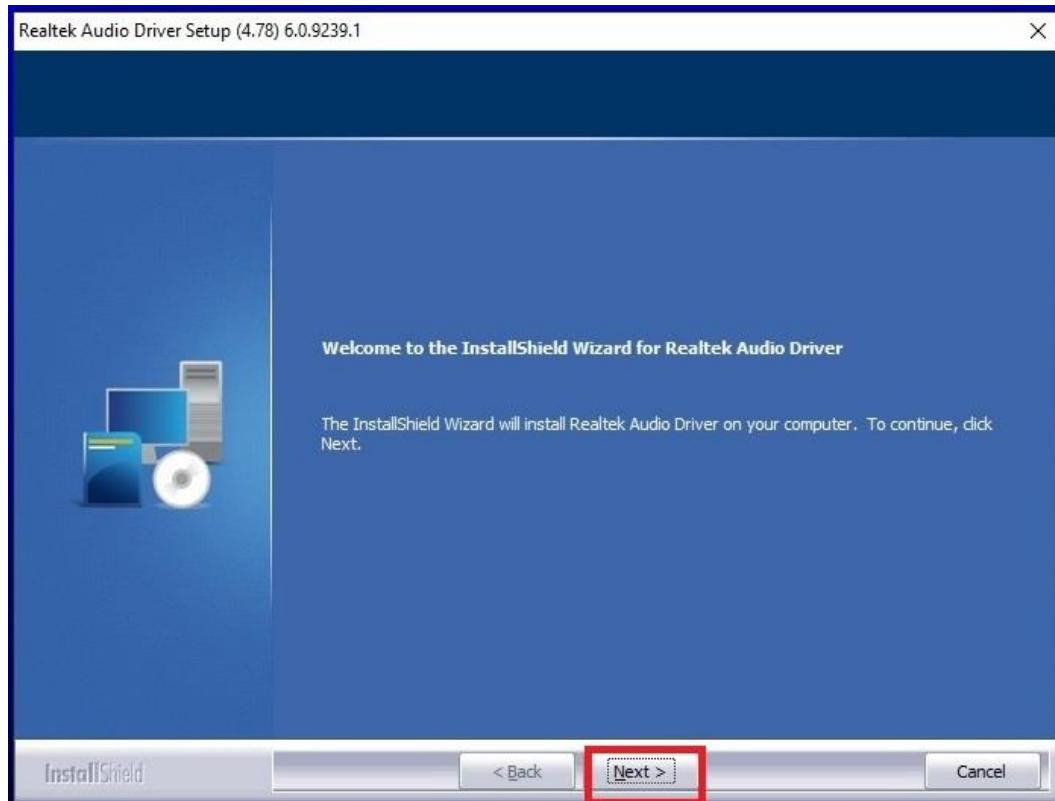

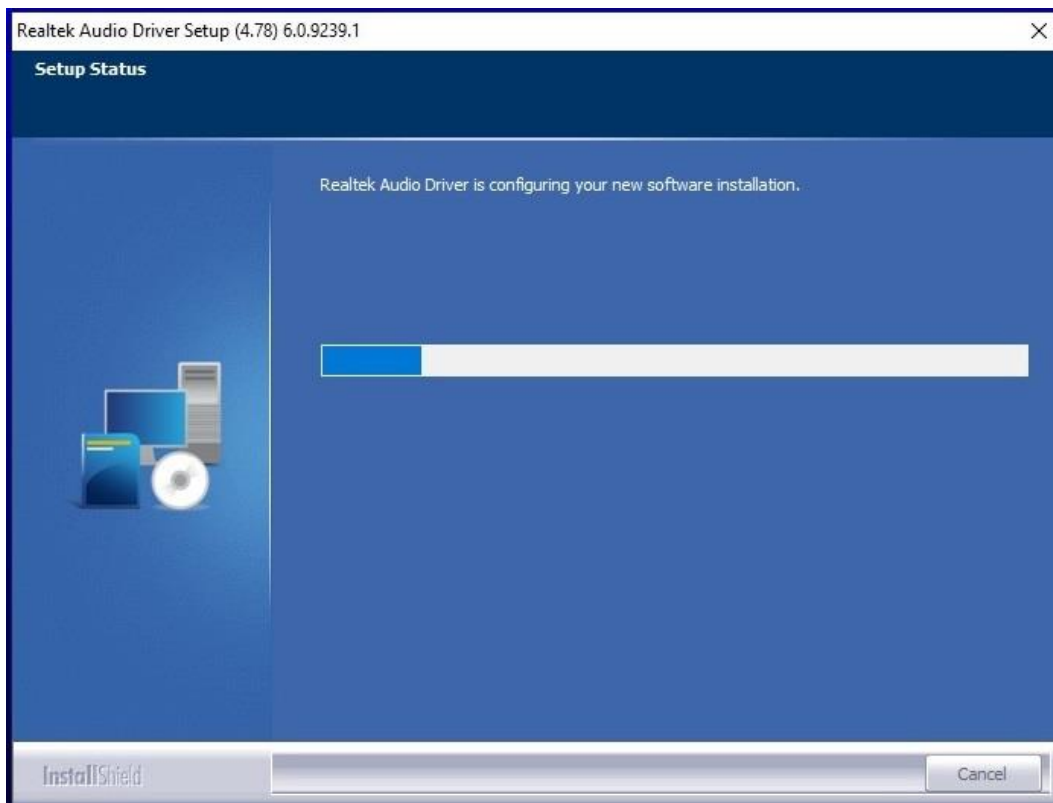
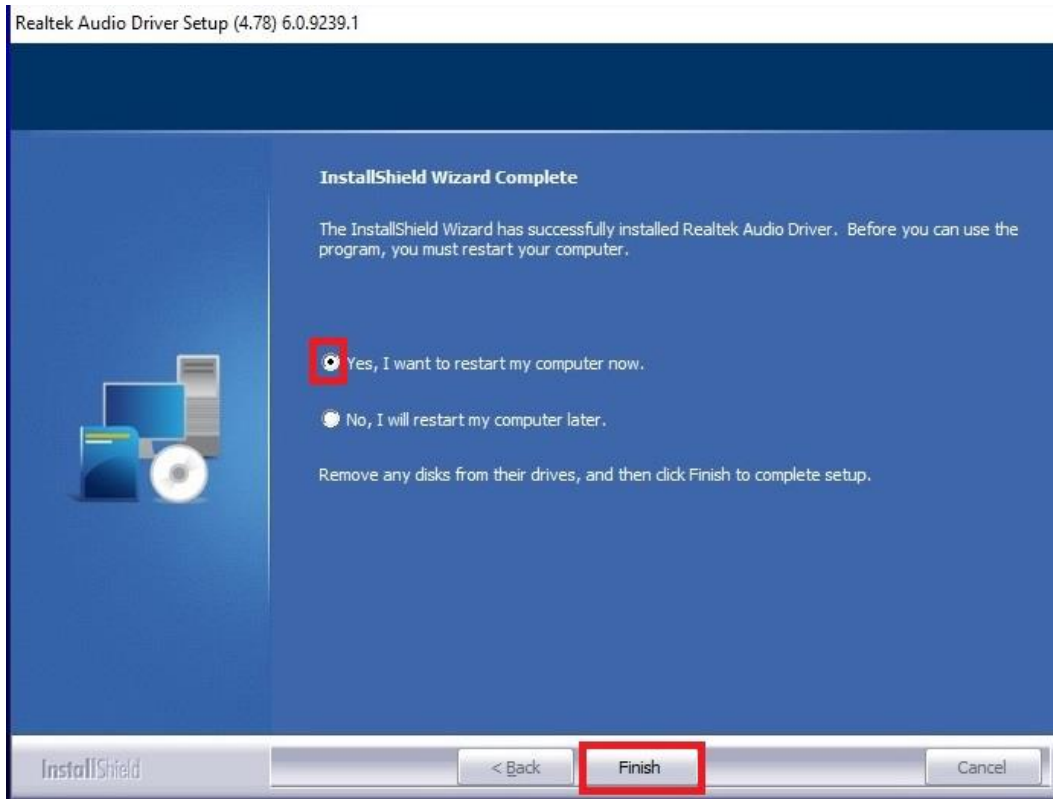

## 4.4 LAN Driver Setup

4.4.1 Go to " Intel LAN 27.7" folder and choose " Autorun.exe"

4.4.2 Please follow the red blank.

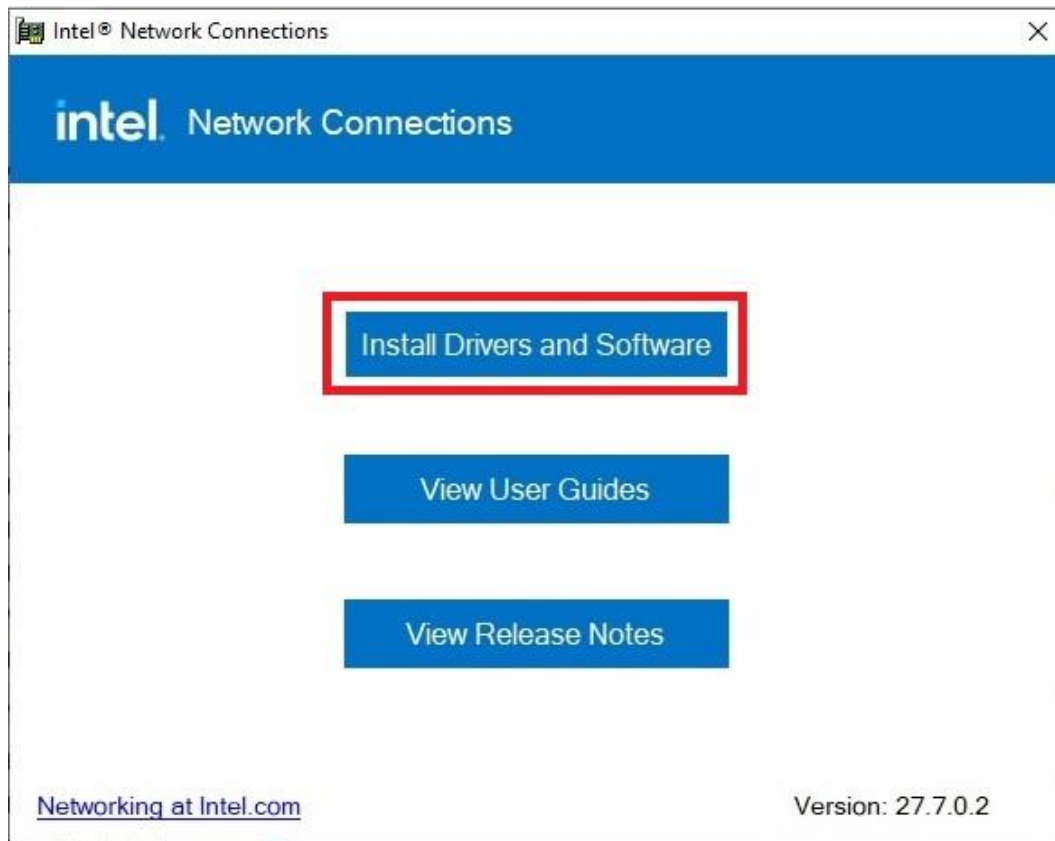

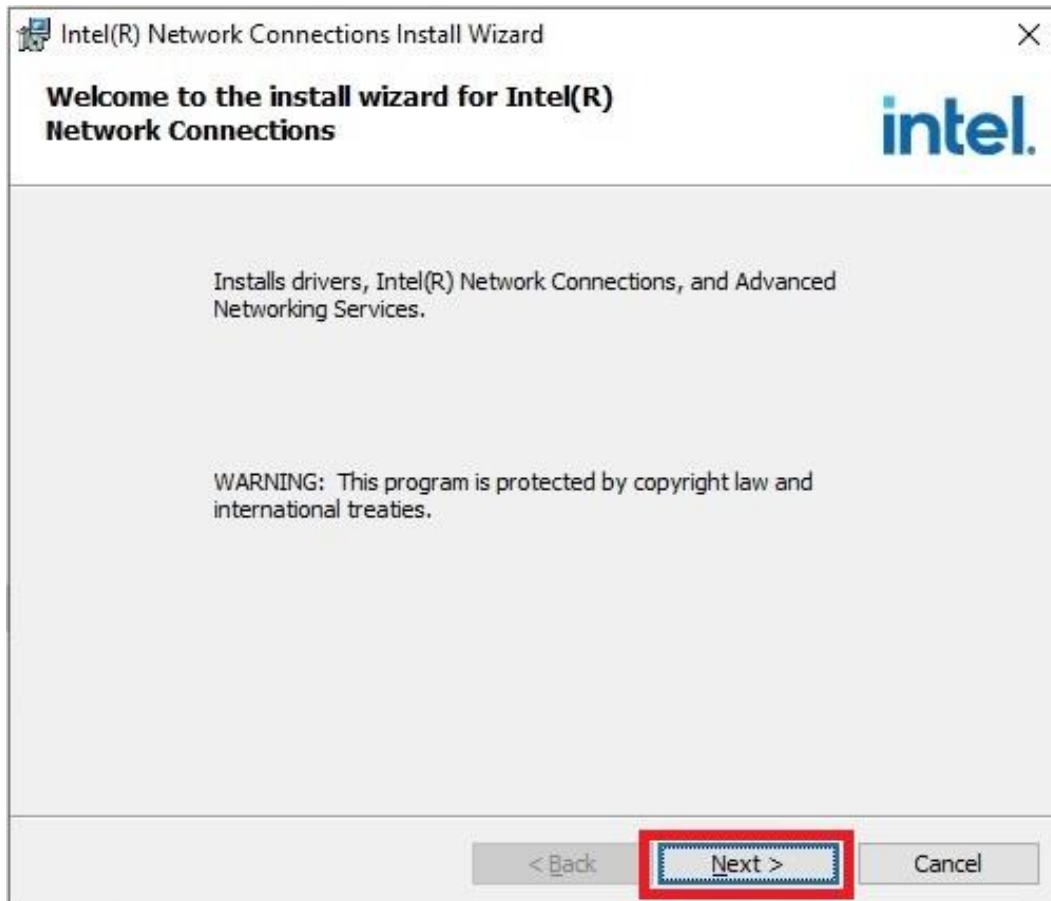

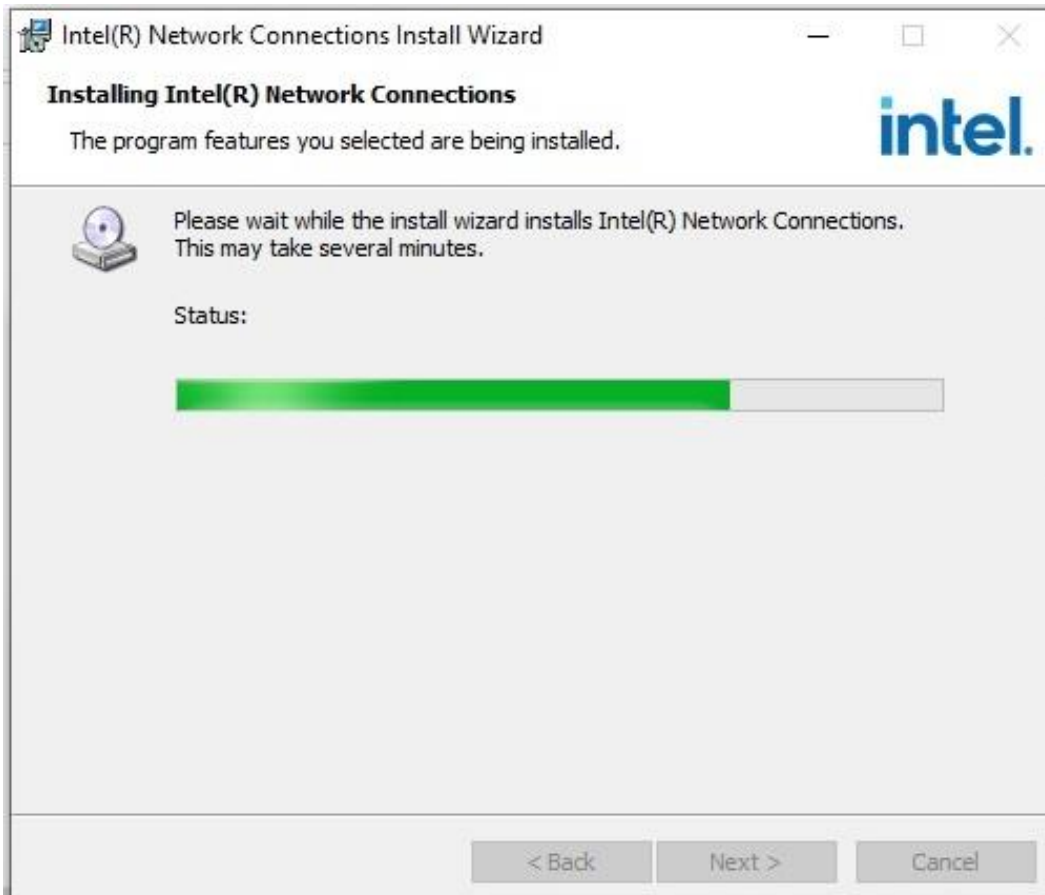
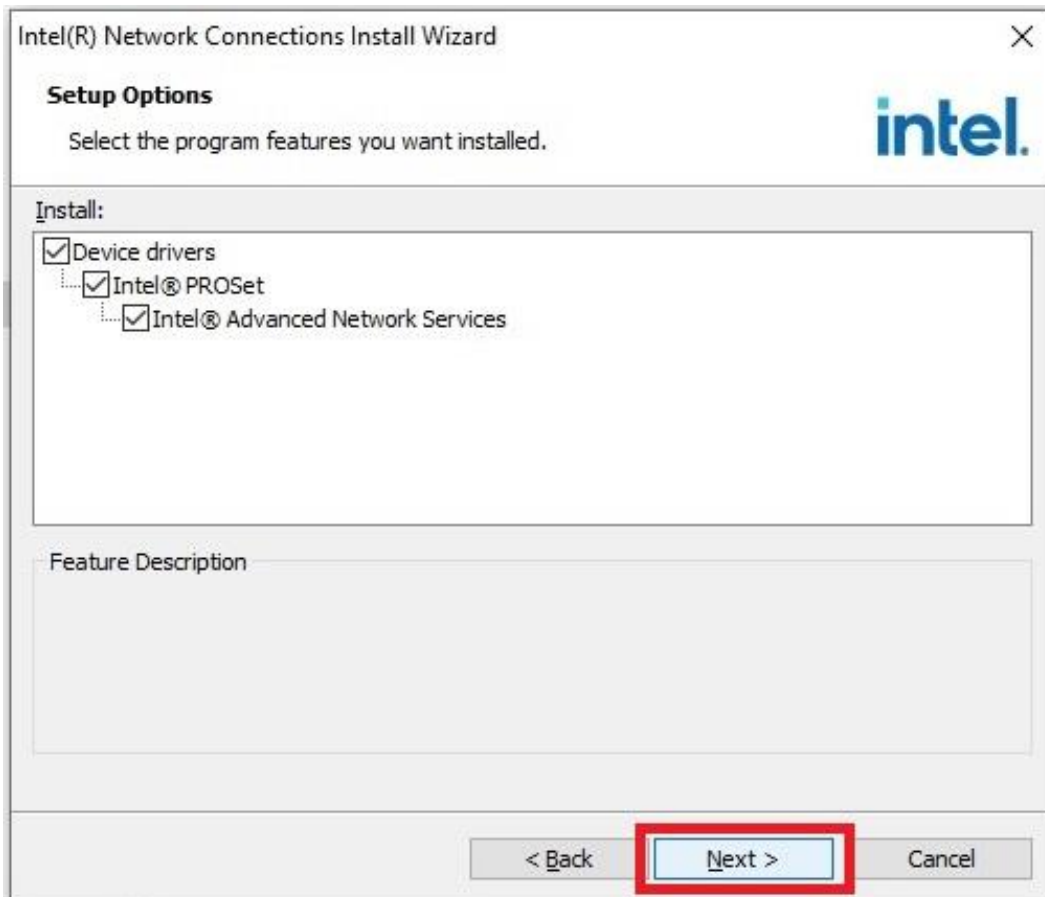



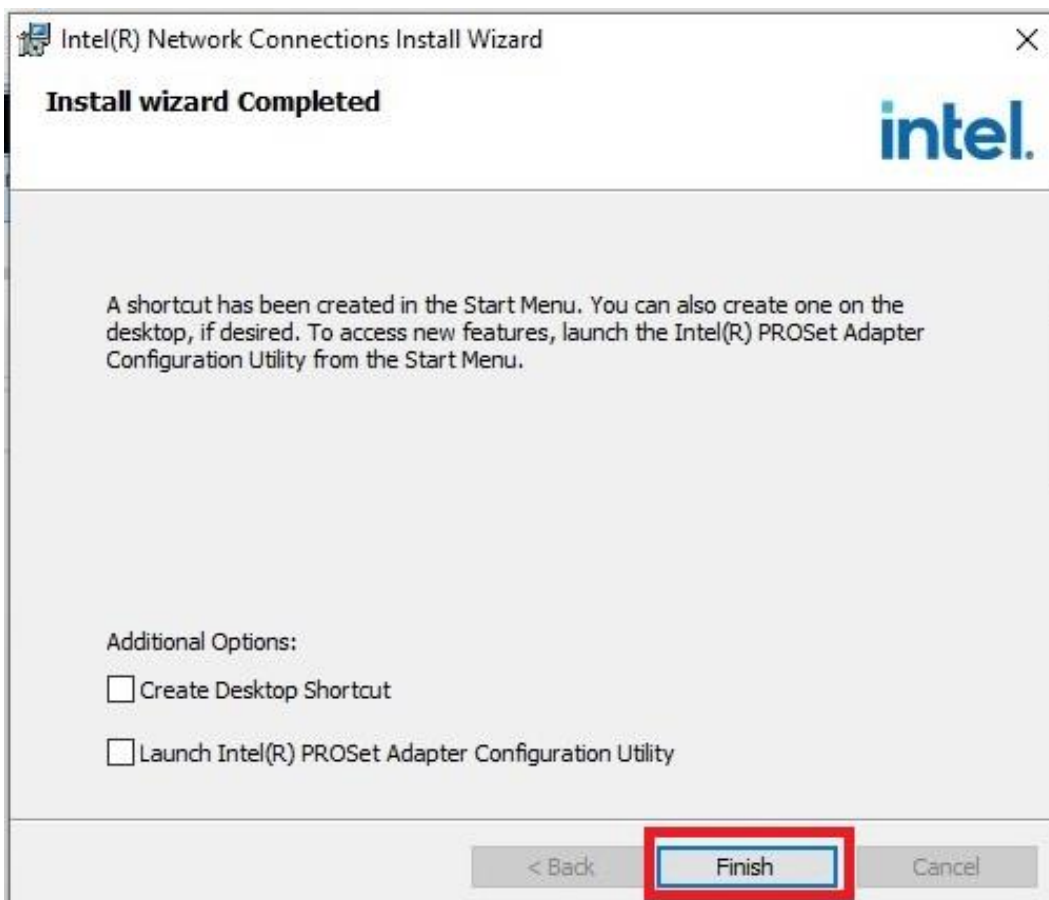
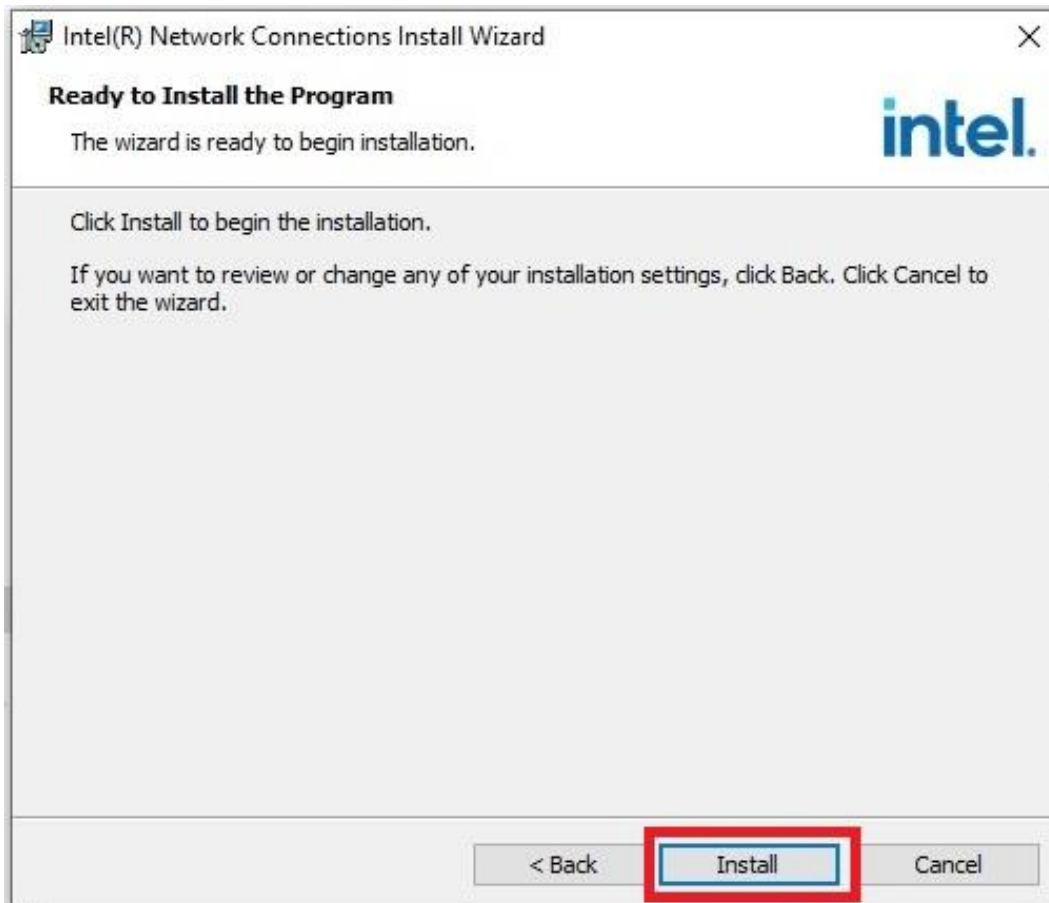

## 4.5 ME Driver Setup

4.5.1 Go to “ME(v16.0.15.1620\_CORP\_SW\_DCH)” and choose “SetupME.exe”

4.5.2 Please follow the red blank.



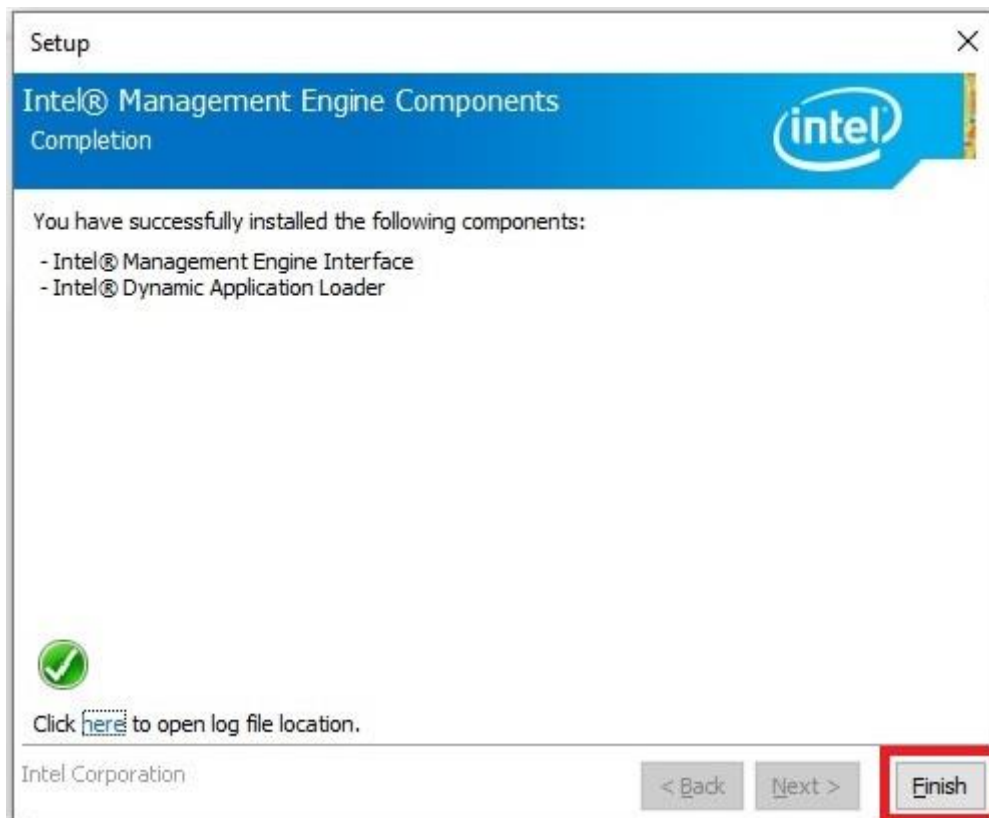
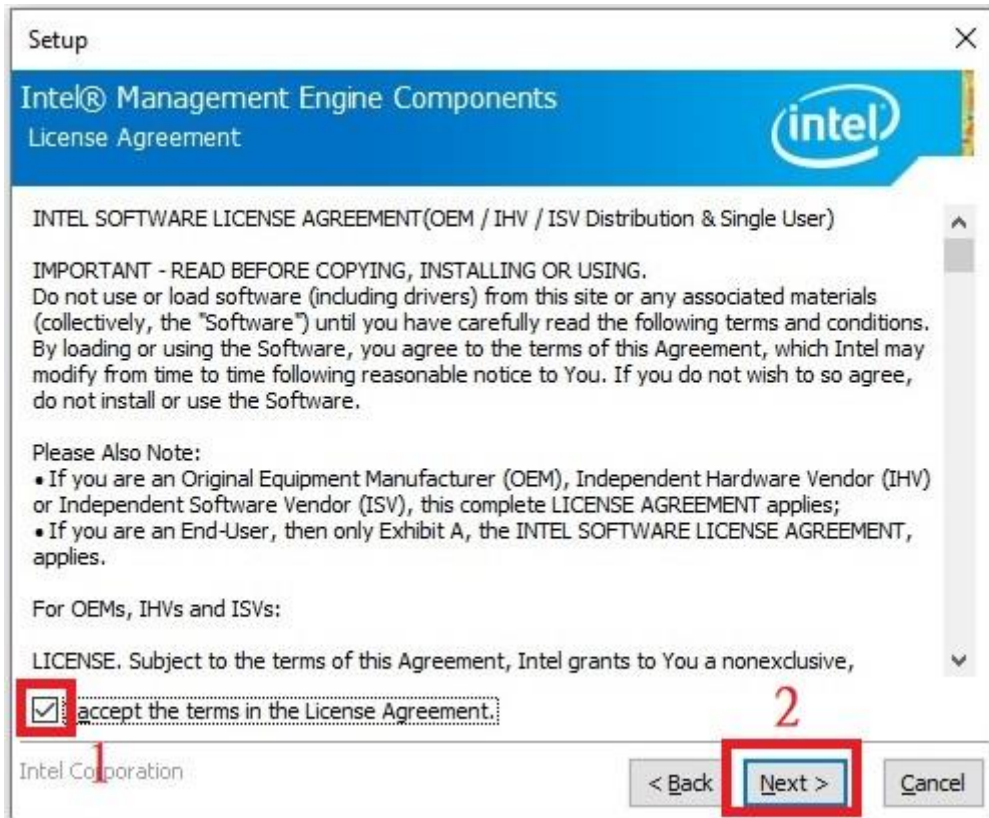

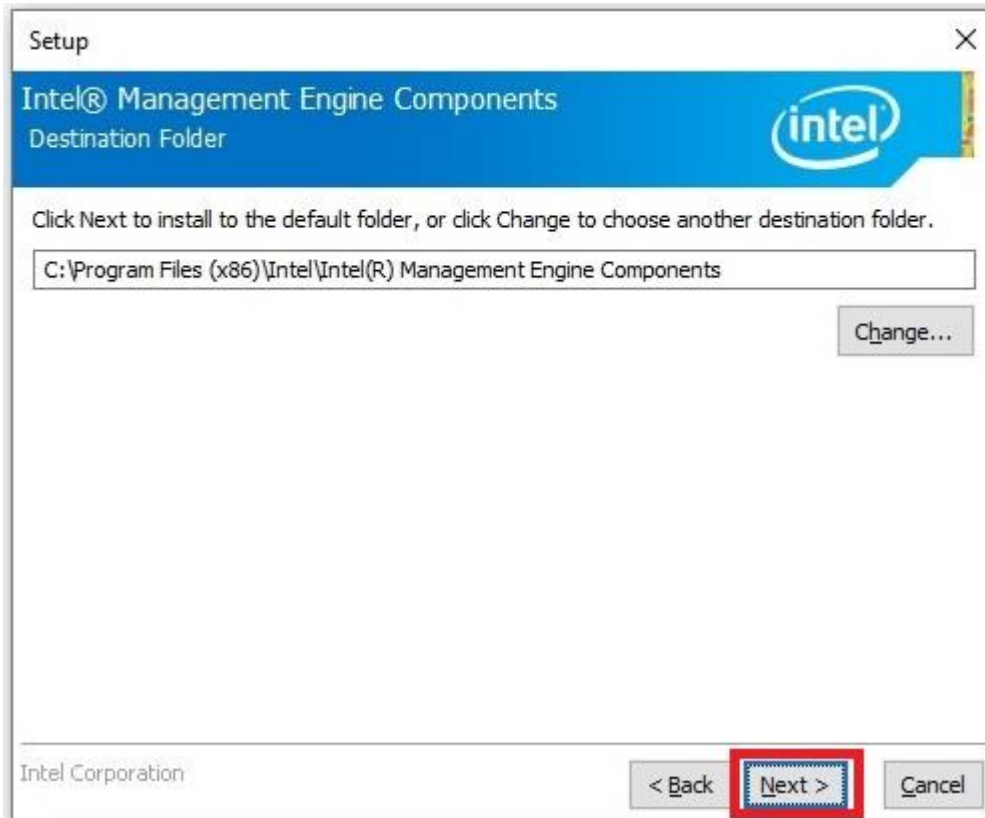

# History

Revision		Date	Modification	Note
0.1		2023/10/11	1 <sup>st</sup> Release	